



Calhoun: The NPS Institutional Archive
DSpace Repository

Theses and Dissertations

1. Thesis and Dissertation Collection, all items

2005-09

Dynamic escape routes for Naval ships

Perez Villalonga, Francisco J.

Monterey California. Naval Postgraduate School

<http://hdl.handle.net/10945/2085>

Downloaded from NPS Archive: Calhoun



Calhoun is the Naval Postgraduate School's public access digital repository for research materials and institutional publications created by the NPS community. Calhoun is named for Professor of Mathematics Guy K. Calhoun, NPS's first appointed -- and published -- scholarly author.

Dudley Knox Library / Naval Postgraduate School
411 Dyer Road / 1 University Circle
Monterey, California USA 93943

<http://www.nps.edu/library>



**NAVAL
POSTGRADUATE
SCHOOL**

MONTEREY, CALIFORNIA

THESIS

DYNAMIC ESCAPE ROUTES FOR NAVAL SHIPS

by

Francisco J. Pérez Villalonga

September 2005

Thesis Advisor:
Second Reader:

Javier Salmerón
Kevin Wood

Approved for public release; distribution is unlimited.

THIS PAGE INTENTIONALLY LEFT BLANK

| REPORT DOCUMENTATION PAGE | | | Form Approved OMB No. 0704-0188 | |
|--|--|---|---|--|
| Public reporting burden for this collection of information is estimated to average 1 hour per response, including the time for reviewing instruction, searching existing data sources, gathering and maintaining the data needed, and completing and reviewing the collection of information. Send comments regarding this burden estimate or any other aspect of this collection of information, including suggestions for reducing this burden, to Washington headquarters Services, Directorate for Information Operations and Reports, 1215 Jefferson Davis Highway, Suite 1204, Arlington, VA 22202-4302, and to the Office of Management and Budget, Paperwork Reduction Project (0704-0188) Washington DC 20503. | | | | |
| 1. AGENCY USE ONLY (Leave blank) | | 2. REPORT DATE September 2005 | 3. REPORT TYPE AND DATES COVERED Master's Thesis | |
| 4. TITLE AND SUBTITLE: Dynamic Escape Routes for Naval Ships | | | 5. FUNDING NUMBERS | |
| 6. AUTHOR(S) Francisco J. Perez Villalonga | | | | |
| 7. PERFORMING ORGANIZATION NAME(S) AND ADDRESS(ES) Naval Postgraduate School Monterey, CA 93943-5000 | | | 8. PERFORMING ORGANIZATION REPORT NUMBER | |
| 9. SPONSORING /MONITORING AGENCY NAME(S) AND ADDRESS(ES) N/A | | | 10. SPONSORING/MONITORING AGENCY REPORT NUMBER | |
| 11. SUPPLEMENTARY NOTES The views expressed in this thesis are those of the author and do not reflect the official policy or position of the Department of Defense or the U.S. Government. | | | | |
| 12a. DISTRIBUTION / AVAILABILITY STATEMENT Approved for public release; distribution is unlimited. | | | 12b. DISTRIBUTION CODE | |
| 13. ABSTRACT (maximum 200 words) This thesis addresses the problem of optimal evacuation of a naval ship. We propose the use of a dynamic escape-route system which employs a signaling system to adapt the emergency egress process to the instigating contingency. The evacuation process is represented by a nonlinear network optimization model with an objective function that integrates two conflicting goals: the average evacuation time and the ship's integrity. The nonlinearity in the model results from (a) speed being a nonlinear function of concurrent flow on passageways, and (b) delays caused by opening closures. We also account for counter-flows and passageways used by repair parties. The problem is heuristically solved through an iterative process that updates speeds and delays as it proceeds, and dynamically adds valid inequalities to avoid counter-flows. A bound on the solution quality is obtained by solving the problem under optimistic conditions. Compared to static routes in a modern frigate, model solutions show that dynamic routes can improve the average evacuation time by 20%, reduce the time of the last evacuee by 25%, and improve ship integrity. We also demonstrate that even greater improvements are achievable with minor design changes in the ship. | | | | |
| 14. SUBJECT TERMS Military problems; Ship evacuation; Network optimization | | | 15. NUMBER OF PAGES 121 | |
| | | | 16. PRICE CODE | |
| 17. SECURITY CLASSIFICATION OF REPORT Unclassified | 18. SECURITY CLASSIFICATION OF THIS PAGE Unclassified | 19. SECURITY CLASSIFICATION OF ABSTRACT Unclassified | 20. LIMITATION OF ABSTRACT UL | |

THIS PAGE INTENTIONALLY LEFT BLANK

Approved for public release; distribution is unlimited.

DYNAMIC ESCAPE ROUTES FOR NAVAL SHIPS

Francisco J. Pérez Villalonga
Lieutenant Commander, Spanish Navy
M.S., Naval Architect, Universidad Politécnica de Madrid (Spain) 1999

Submitted in partial fulfillment of the
requirements for the degree of

MASTER OF SCIENCE IN OPERATIONS RESEARCH

from the

NAVAL POSTGRADUATE SCHOOL
September 2005

Author: Francisco J. Pérez Villalonga

Approved by: Javier Salmerón
Thesis Advisor

Kevin Wood
Second Reader

James N. Eagle
Chairman, Department of Operations Research

THIS PAGE INTENTIONALLY LEFT BLANK

ABSTRACT

This thesis addresses the problem of optimal evacuation of a naval ship. We propose the use of a dynamic escape-route system which employs a signaling system to adapt the emergency egress process to the instigating contingency.

The evacuation process is represented by a nonlinear network optimization model with an objective function that integrates two conflicting goals: the average evacuation time and the ship's integrity. The nonlinearity in the model results from (1) speed being a nonlinear function of concurrent flow on passageways, and (2) delays caused by opening closures. We also account for counter-flows and passageways used by repair parties.

The problem is heuristically solved through an iterative process that updates speeds and delays as it proceeds, and dynamically adds valid inequalities to avoid counter-flows. A bound on the solution quality is obtained by solving the problem under optimistic conditions.

Compared to static routes in a modern frigate, model solutions show that dynamic routes can improve the average evacuation time by 20%, reduce the time of the last evacuee by 25%, and improve ship integrity. We also demonstrate that even greater improvements are achievable with minor design changes in the ship.

THIS PAGE INTENTIONALLY LEFT BLANK

TABLE OF CONTENTS

| | | |
|-------------|---|-----------|
| I. | INTRODUCTION..... | 1 |
| | A. BETTER EVACUATION OF NAVAL SHIPS..... | 1 |
| | 1. The Problem | 1 |
| | 2. The Model | 3 |
| | 3. Justification Of Dynamic Escape Routes..... | 4 |
| | B. NAVAL SHIPS EVACUATION PROCESS | 5 |
| | C. MODELING NAVAL-SHIP EVACUATION..... | 9 |
| | 1. From Passenger-Ship Models To Naval-Ship Models | 9 |
| | 2. Overview Of The Optimization Model | 10 |
| | D. THESIS OUTLINE..... | 11 |
| II. | MATHEMATICAL FORMULATION | 13 |
| | A. INTRODUCTION..... | 13 |
| | B. INDICES AND SETS OF INDICES | 15 |
| | C. PARAMETERS [UNITS]..... | 16 |
| | D. DECISION VARIABLES | 17 |
| | E. OBJECTIVE FUNCTION AND CONSTRAINTS..... | 17 |
| | F. DESCRIPTION..... | 19 |
| III. | SOLUTION METHODOLOGY | 21 |
| | A. DESCRIPTION..... | 21 |
| IV. | CASE STUDY | 25 |
| | A. INTRODUCTION..... | 25 |
| | B. NODES..... | 27 |
| | 1. Node ID | 28 |
| | 2. Type..... | 28 |
| | <i>a. Compartments</i> | <i>28</i> |
| | <i>b. Closures</i> | <i>29</i> |
| | <i>c. Mustering Stations</i> | <i>29</i> |
| | 3. Material Condition Of Readiness | 30 |
| | 4. Coordinates..... | 30 |
| | 5. Source Nodes | 31 |
| | C. ARCS..... | 33 |
| V. | TEST SCENARIOS..... | 35 |
| | A. SCENARIO OVERVIEW | 35 |
| | B. INTACT-SHIP SCENARIOS..... | 37 |
| | C. DAMAGED-SHIP SCENARIOS | 43 |
| | 1. USS STARK Case | 43 |
| | 2. USS COLE Case..... | 46 |
| | D. DESIGN ASPECTS | 49 |
| | E. MODEL DETAILS AND ALGORITHM PERFORMANCE..... | 55 |
| VI. | CONCLUSIONS AND RECOMMENDATIONS..... | 57 |
| | A. CONCLUSIONS | 57 |

| | | |
|--|--|------------|
| B. | RECOMMENDATIONS FOR FURTHER STUDY | 58 |
| LIST OF REFERENCES..... | | 61 |
| APPENDIX A. | MATERIAL CONDITION OF READINESS..... | 69 |
| APPENDIX B. | CREW LOCATION | 71 |
| APPENDIX C. | COMPARTMENT DESIGNATION NUMBERING SYSTEM...81 | |
| A. | DECK NUMBERS | 82 |
| B. | FRAME NUMBER | 83 |
| C. | SIDE NUMBER | 83 |
| D. | USAGE LETTER | 84 |
| APPENDIX D. | CLOSURES | 87 |
| INITIAL DISTRIBUTION LIST | | 101 |

LIST OF FIGURES

| | | |
|------------|--|----|
| Figure 1. | Evacuation process for a naval ship and points at which a dynamic escape plan can be defined | 8 |
| Figure 2. | Walking speed of pedestrians as a function of flow. | 14 |
| Figure 3. | Representative walking speed as a function of concurrent flow..... | 24 |
| Figure 4. | F-101 ÁLVARO DE BAZÁN. | 25 |
| Figure 5. | Building the DER network for the ÁLVARO DE BAZÁN from technical drawings..... | 26 |
| Figure 6. | Node data sheet. | 28 |
| Figure 7. | Mustering stations on the ÁLVARO DE BAZÁN. | 30 |
| Figure 8. | Coordinate reference system for the ÁLVARO DE BAZÁN. | 31 |
| Figure 9. | Looking down an escape trunk. | 33 |
| Figure 10. | Arc data..... | 34 |
| Figure 11. | Comparing dynamic and static escape routes for intact-ship scenarios and general quarters condition..... | 40 |
| Figure 12. | Comparing dynamic and static escape routes for intact-ship scenarios and watch condition..... | 41 |
| Figure 13. | Comparing dynamic and static escape routes for intact-ship scenarios and port condition..... | 42 |
| Figure 14. | Comparing dynamic and static escape routes for the damaged-ship scenario: USS STARK case, watch condition..... | 46 |
| Figure 15. | Comparing dynamic and static escape routes for damaged-ship scenario, USS COLE case, port condition. | 49 |
| Figure 16. | Comparing dynamic and static escape routes for new design: additional forecastle exit under port condition | 54 |
| Figure 17. | Example of node label following CDNS standard..... | 81 |
| Figure 18. | Deck numbers. | 82 |
| Figure 19. | Station number..... | 83 |
| Figure 20. | Side number. | 84 |
| Figure 21. | Quick- Acting WTD | 88 |
| Figure 22. | Quick Acting ATD..... | 88 |
| Figure 23. | Raised WTH..... | 89 |
| Figure 24. | Raised WTH with Scuttle | 89 |
| Figure 25. | Raised WTS | 90 |
| Figure 26. | Flush WTS | 90 |

THIS PAGE INTENTIONALLY LEFT BLANK

LIST OF TABLES

| | | |
|-----------|--|-----|
| Table 1. | Material Condition of Readiness..... | 6 |
| Table 2. | Number of nodes per deck or level..... | 27 |
| Table 3. | Estimated time to open a closure by the first group of evacuees..... | 29 |
| Table 4. | Crew distribution by deck and condition on the ÁLVARO DE BAZÁN..... | 32 |
| Table 5. | Intact-ship scenarios: Three cases analyzed..... | 35 |
| Table 6. | Objective-function comparison for intact ship scenarios..... | 37 |
| Table 7. | Evacuation time comparison for intact-ship scenarios..... | 38 |
| Table 8. | Ship integrity comparison for intact-ship scenarios..... | 39 |
| Table 9. | Number of crewmembers that assemble at each mustering station for intact-ship scenarios..... | 39 |
| Table 10. | Objective-function, evacuation-time and ship-integrity comparisons for the damaged-ship scenario on the “USS STARK case.”..... | 45 |
| Table 11. | Objective function, evacuation time and ship integrity comparison for damaged-ship scenario, USS COLE case..... | 48 |
| Table 12. | Objective function, evacuation time and ship integrity comparison for new design under general quarters and no damage..... | 51 |
| Table 13. | Objective function, evacuation time and ship integrity comparison for new design under watch and no damage..... | 52 |
| Table 14. | Objective function, evacuation time and ship integrity comparison for new design under port and no damage..... | 53 |
| Table 15. | Summary of computational results..... | 55 |
| Table 16. | Crew Location – Deck 4 and below..... | 71 |
| Table 17. | Crew Location – Deck 3..... | 72 |
| Table 18. | Crew Location – Deck 2..... | 74 |
| Table 19. | Crew Location – Deck 1..... | 75 |
| Table 20. | Crew Location – Deck 01..... | 75 |
| Table 21. | Crew Location – Deck 02..... | 75 |
| Table 22. | Crew Location – Deck 03..... | 75 |
| Table 23. | Source-node Cartesian coordinates..... | 79 |
| Table 24. | Extensive list of closures on naval ships..... | 87 |
| Table 25. | Closure location on ÁLVARO DE BAZÁN frigate..... | 100 |

THIS PAGE INTENTIONALLY LEFT BLANK

LIST OF TERMS AND ABBREVIATIONS

| | |
|--------|---|
| AP | Aft perpendicular |
| BL | Baseline |
| CDNS | Compartment Designation Numbering System |
| CIWS | Close-In Weapons System |
| CL | Centerline |
| CO | Commanding Officer |
| DCRS | Damage Control Repair Station |
| DIN | Deutsches Institut für Normung |
| EEBD | Emergency Escape Breathing Device |
| FP | IMO sub-committee on Fire Protection |
| FP | Forward perpendicular |
| IMO | International Maritime Organization |
| ISO | International Organization for Standardization |
| MCR | Material Condition of Readiness |
| MSC | Maritime Safety Committee |
| NAVSEA | Naval Sea Systems Command |
| NFPA | National Fire Protection Association. |
| NSTC | Lloyd's Register Naval Ship Technical Committee |
| RCS | Radar Cross Section. |
| RHIB | Rigid Hull Inflatable Boats |
| SEAFG | Safety Equipment and Arrangements Focus Group |
| SFPE | Fire Protection Engineering Handbook |
| SOLAS | Safety of Life at Sea Convention |
| U.K. | United Kingdom |
| U.S. | United States of America |

THIS PAGE INTENTIONALLY LEFT BLANK

ACKNOWLEDGMENTS

The author would like to thank Professor Javier Salmeron for his support and gentle but firm direction, guiding me toward a qualitative methodology. Thanks are also due to Professor Kevin Wood for the opportunity to expose this work to the community.

In addition to the assistance above, I received equally important assistance from my family and friends. Words alone cannot express the thanks I owe to my wife Angeles, for her inestimable support throughout these years.

Finally, to my little children Victor and Blanca. They do not understand now why their father spent two years in front a computer but they did their best to entertain him by paying regular visits to his study room.

THIS PAGE INTENTIONALLY LEFT BLANK

EXECUTIVE SUMMARY

This thesis addresses the problem of optimal evacuation of a naval ship. Specifically, we propose and demonstrate the use of a dynamic escape-route system. This system uses signals that adapt to the instigating contingency and optimally guide personnel through egress routes to mustering stations. The system optimizes a weighted combination of average evacuation time and a measure of ship integrity.

Before the event of abandonment, we encounter up to three opportunities to set up escape routes: (1) Normal-operation phase: Escape-route signals can be configured based on the actual crew distribution (e.g. general quarters) and the ordered material condition of readiness; (2) Awareness phase: Escape routes can be set up based on, for example, the direction of an approaching missile and the most likely impact zone; and, (3) Salvage phase: Escape routes can be configured to account for identified damaged and unavailable passages.

We represent the evacuation process of a naval ship by a nonlinear network-flow optimization model. The network's topology is derived from technical and construction drawings, with nodes representing compartments, closures and intersections, and arcs representing passages and stairways. Source nodes represent groups of collocated crewmembers, and modified sink nodes represent mustering stations. The objective function integrates two factors: (1) The average evacuation time of all the groups of crewmembers, and (2) the watertight and airtight integrity of the ship after the muster phase of the evacuation. These two objectives can conflict, however: For example, opening a watertight door may speed egress, but may also degrade the ship's integrity.

The nonlinearity in the optimization model arises from two factors: (1) Speed is a nonlinear function of concurrent flow on a passageway. This means that the speed at which crewmembers traverse a given arc depends on how many attempt to do that simultaneously. (2) A delay is incurred by a group that first reaches and opens a watertight or airtight door, but that delay does not directly apply to groups that pass through that doorway subsequently. Another complexity of this model results from the large number of constraints that may be needed to avoid counter-flows.

The optimization problem is heuristically solved in an iterative algorithm that (1) fixes nonlinear terms involving speeds and delays, (2) solves a linear approximating model, (3) adds valid inequalities to eliminate counter-flows currently exhibited, and (4) repeats steps (1)-(3) until a consistent solution is found. A bound on the solution quality is obtained by solving the problem under ideal conditions (i.e., maximum walking speed with all doors opened).

Solutions obtained using data from a modern Spanish frigate show that a dynamic escape-route system can improve evacuation time by 20% and improve the ship's integrity by 26% compared to a system of static routes. Moreover, we demonstrate that with minor design changes, these improvements can be even greater.

This model could be a useful tool for the design and operation of the naval ship. We recommend further study using fully validated data and simulation exercises on existing ships and ship prototypes for the purpose of a more realistic assessment of the proposed model.

I. INTRODUCTION

This thesis addresses the problem of optimal evacuation of a naval ship. We propose the use of a dynamic escape-route system which uses signals to adapt the emergency egress process to the instigating contingency.

A. BETTER EVACUATION OF NAVAL SHIPS

1. The Problem

Because of their combatant nature, naval ships are exposed to more threats than passenger and other commercial ships. The abandonment of a naval ship is an unlikely event, but if it does occur, it is likely to be under the worst of circumstances. Thus, the evacuation leading up to abandonment must be accomplished as quickly and effectively as possible.

Doctrine regarding the evacuation process is evolving in order to accommodate two tendencies: (1) Manning reduction (Lazinsky, 2005; Hinkle, 2004), and (2) adaptation of non-naval rules for naval ship design and construction (Marinelog, 2004).

Due to reduced manning levels on modern naval ships, the size of damage-control parties has been reduced. Thus, we contend that, nowadays, a naval ship in distress is more likely than ever to be abandoned.

Naval ships are exempt from Safety of Life at Sea (SOLAS) regulations, which are mandatory for merchant ships (Taylor, 2004). However, some navies, like the British Royal Navy, are already moving towards SOLAS (called “naval SOLAS”). The International Maritime Organization (IMO) is in charge, under the United Nations, of establishing standards and procedures (see MSC/Circ. 1033, 2002) that satisfy SOLAS, but naval ships are only required to achieve a level of safety that is “as good as” that of merchant ships (Taylor, 2004).

However, the U.S. Coast Guard has raised concerns regarding the methodology used by the IMO for analyzing the passenger-ship evacuation process (Evacuation Analysis Plan, 2005). The data used by these models and some modeling simplifications are some of the sources of major criticism:

- The analysis methodology is based on that intended for buildings. For example, data regarding the speed of evacuees is derived from stairs, corridors and doors in civil building (SFPE Fire Protection Engineering Handbook, 1995).
- Effects of ship motion, passenger age and disability, restricted visibility due to smoke and other difficulties, are accounted for only through a vaguely defined “safety factor.”
- The methodology assumes that people can move unhindered, that no escape routes are blocked, and that all passengers will evacuate via primary routes.

At present, evacuation systems on naval ships, as on passenger and merchant ships, use static signals to mark escape routes and direct evacuees to mustering stations. These systems do not make any provision for blocked passages and/or closures, but rather, rely on crewmembers’ skills to find an alternative route if they find a blocked passage.

Because a naval ships’ crew is a well-trained, homogeneous group, and its members have considerable knowledge of their ship, we may expect that a naval crew will be able to evacuate its ship more efficiently than, for example, an untrained, heterogeneous group passengers on a passenger vessel. However, even for naval crews, static evacuation signals can be inefficient. A better system is possible.

This thesis explores the use of a dynamic escape-route system (DER) in the evacuation process of a naval ship, and compares that system to the current static one. Escape routes in a DER may be configured to accommodate factors such as crew distribution, expected threats, or actual damage to the ship.

We demonstrate the improvements that a DER may have over a static escape-route system by:

- Reducing the average evacuation time (and, as a by-product, the time of the last evacuee), and
- Improving the ship’s watertight and airtight integrity, which, in turn will:

- Increase the likelihood of successfully salvaging the ship, and
- Increase the likelihood that the crew is rescued safely.

It will be possible to reduce evacuation time with DER because the flow of evacuees can be better controlled to reduce overcrowding, to avoid passageways that are impassable, etc. The ship's integrity can be improved because the number of watertight and airtight closures that must be opened can be minimized.

2. The Model

This "optimal evacuation problem" is addressed by building a multi-commodity directed-network model derived from technical drawings: Nodes represent compartments, closures and intersections, and arcs represent passages and stairways.

Each group of evacuees in a compartment is viewed as a "commodity," and compartment occupancy at the time of the contingency represents "supply" of that commodity at a source node. Nodes representing mustering station are connected by arcs to a super-sink whose demand equals the total supply of evacuees. Each of these arcs has a capacity that represents the limit on the number of evacuees that may occupy the particular mustering station.

The objective function integrates two factors: (1) The average evacuation time of all the groups of crewmembers, and (2) the watertight and airtight integrity of the ship after the muster phase of the evacuation. These two objectives can conflict, however: For example, opening a watertight door may speed egress, but it may also degrade the ship's integrity.

The non-linearity in the network optimization model arises from two main factors: (1) Speed is a nonlinear function of concurrent flow on a passageway. This means that the speed at which crewmembers traverse a given arc depends on the number of crewmembers that are attempting to traverse that arc simultaneously. (2) A delay is applied to the first group that reaches and opens a watertight or airtight door, but not directly to groups that cross through that doorway subsequently.

We solve the problem approximately with a customized heuristic algorithm that uses a technique similar to successive linear programming (e.g., Fletcher and Sainz,

1989). Essentially, in each iteration, we replace nonlinear terms such as $h(x)x$ with $h(\hat{x})x$, using the most recently computed value of x as \hat{x} , and then solve the resulting, approximating linear program. The new solution is used to readjust nonlinear terms, and the process repeats until no further adjustments are necessary. A bound on solution quality is obtained by solving the problem under ideal conditions (i.e., maximum walking speed with all doors opened).

We test our model and algorithm using data from a recently built Spanish F-100 frigate, the *ÁLVARO DE BAZÁN*.

3. Justification Of Dynamic Escape Routes

After studying the methodology used to evaluate the evacuation process of passenger and merchant ships required by the IMO (MSC/Circ 1033, 2002), we identify important differences with the analogous process for naval ships with respect to (1) the makeup of a shipboard population, (2) the sequence of events leading up to an evacuation, and (3) information about the shipboard population's location. We can take advantage of these differences in order to improve the evacuation process on naval ships through DER:

- We may assume that the disciplined crew of a naval ship will expect and respect dynamic signaling. Their training and homogeneity ensures that they will be able to move at pre-specified speeds, and open any closures they meet along their way, and complete their egress in approximately the same time as estimated by a good model. (The population aboard a passenger ship is heterogeneous and lacks training.)
- The predictable sequence of events before a naval ship evacuation takes place allows us to configure dynamic escape routes in advance of an evacuation. (The events leading up to the evacuation of a passenger vessel are less predictable.)
- As we shall see, the initial physical distribution of the crew plays a decisive role in establishing good evacuation routes. Based on a naval

ships' organization book, crew distribution can be determined by compartment, almost exactly, at any time. (The nature of a passenger ship makes this impossible.)

A system that considers a crew's physical distribution and responds dynamically to a particular contingency must be better than one that is static, as long as it functions properly: The DER problem is a mathematical relaxation of the static problem, so the solution must be better if it is implemented correctly.

B. NAVAL SHIPS EVACUATION PROCESS

The evacuation process of a naval ship (see Figure 1) is a complex process, involving more events and procedures than on a passenger ship (which is described in detail in IMO's MSC/Circ. 1033, 2002).

Naval ships may be anchored or moored in a harbor, transiting to an area of operations, conducting exercises or even fighting. The range of normal operating conditions is broad but, whatever the situation is, the crew will be distributed onboard in accordance with ship's organization book. Naval ships also have a great level of situational awareness and may anticipate a threat, such as an incoming missile. Moreover, when damage occurs, a damage control officer should be able to quickly assess the extent of damage (Practical Damage Control, 1993).

If a naval ship must be evacuated, the initial status of its crew and the ship's condition should be better defined than in a commercial vessel. Thus, we may be able to improve the evacuation process.

Analyzing the sequence of events that may lead to ship abandonment, we identify three opportunities to configure escape routes:

- During the "Normal Operation Phase" or "Pre-abandonment Phase," which spans the period before the event that triggers ship abandonment. Escape routes can be configured based on two factors:

- “Crew distribution,” ordered by the commanding officer (CO), determines which stations are manned and to what extent. Representative instances are:
 - General Quarters: The ship is in battle condition and the totality of the crew is located at combat stations.
 - Watch: About one third of the crew is located in control and weapons stations, one third is resting in their cabins and the rest of crew is working in offices or relaxing in living rooms.
 - Port: All crewmembers but the guards are resting in cabins and berthing rooms. This is a plausible scenario at night when the ship is in a non-home port.

- Material Condition Readiness (MCR), which is the degree of access and system closure in effect at a given time, in anticipation of potential damage to the ship’s integrity. All closures (doors, hatches, etc.) on board are marked with a letter (X, Y, Z). Based on this mark and the ordered MCR (XRAY, YOKE or ZEBRA), Table 1 shows whether a closure is closed or open. XRAY provides the least watertight and airtight integrity and the greatest access throughout the ship, whereas ZEBRA provides the greatest degree of integrity and the least accessibility.

| | | Ordered MCR | | |
|--------------|----------|-------------|-------------|--------------|
| | | XRAY | YOKE | ZEBRA |
| Closure mark | X | Closed | Closed | Closed |
| | Y | Open | Closed | Closed |
| | Z | Open | Open | Closed |

Table 1. Material Condition of Readiness. A ship’s closures remain open or closed depending on their marks and the current MCR.

- A second opportunity to set up escape routes is present when an enemy weapon is shot or launched at the ship and is detected before impact. Despite the limited time available, it is possible to anticipate a likely location of the impact (for example, the ship will maneuver to offer reduced radar cross section to the missile).
- Finally, if hit, the ship is not immediately abandoned. Repair parties will conduct a damage assessment and will try to control and extinguish fires and/or block flooding in order to maintain fighting capability and/or enable a return to port. At this stage, escape routes can be based on the location and extent of the damage. For example, the plan would avoid passages that were destroyed by the impact, avoid mustering stations where life rafts have been destroyed, would limit evacuation using routes needed by repair parties, etc.

If the CO realizes the ship will inevitably be lost, he will finally order abandonment. At that time, crewmembers are still required to conduct an emergency destruction of sensitive materials and equipment (Responsibility for National Security Cases, 2002), especially when sailing in enemy waters. This process is carried out by specialized crewmembers and takes place concomitantly with other crewmembers transiting to mustering stations.

These three opportunities will not necessarily be present in all cases: A naval ship may receive an impact without previous awareness (as with the USS COLE attack in 2000) or the severity of the damage may require the immediate abandonment of the ship (as with the sinking of General Belgrano in 1982).

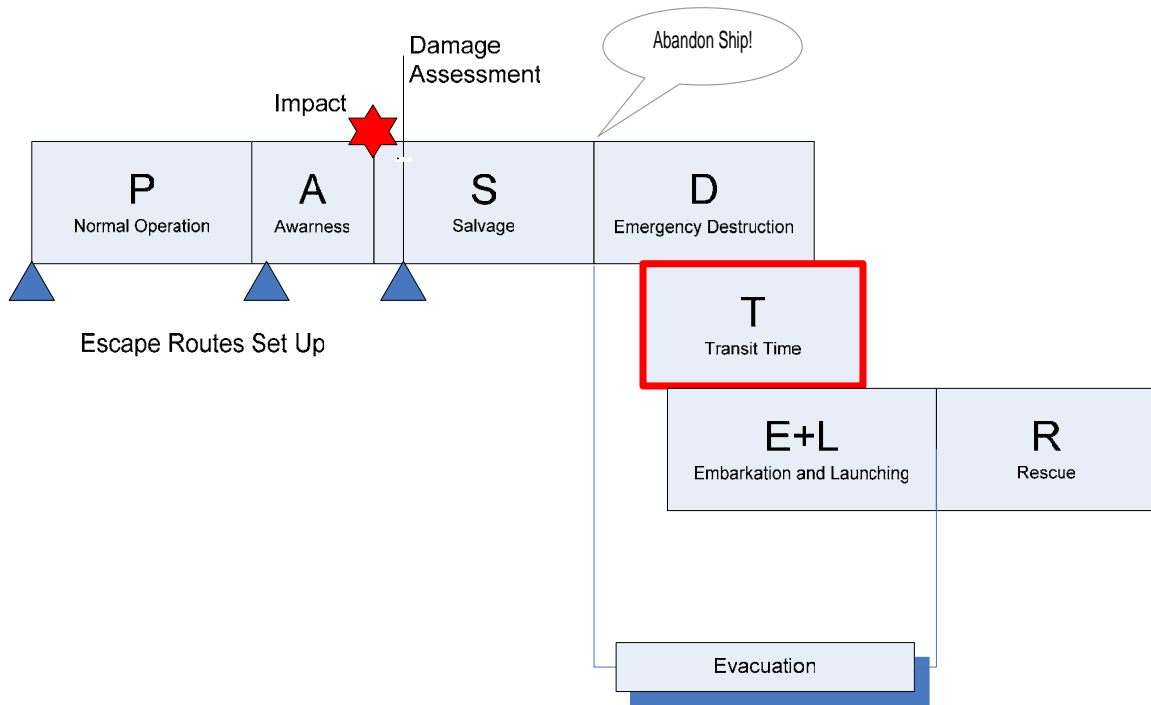

Figure 1. Evacuation process for a naval ship and points at which a dynamic escape plan can be defined. Blue triangles denote those points. This example assumes that the ship has some warning of the impending impact of a weapon, hence the “awareness phase.”

Travel or Muster time (T) is defined by IMO MSC/Circ. 1033 as the time it takes for “all persons” on board to move from where they are (upon notification) to the mustering stations. When arriving at the mustering stations, crewmembers embark onto rescue craft, which are then launched into the sea, or they jump into the water to board life-rafts. The sum of the embarkation time (E) and launching time (L) defines the time required to provide for abandonment of the ship. An additional, difficult-to-predict time (R) passes until rescue of these castaways is accomplished.

Minimizing the transit time of evacuees to mustering stations is an obvious goal of any evacuation model. However, we do not want to accelerate the ship’s sinking by opening more watertight doors than necessary and thus diminish the survival chances for crewmembers that might be delayed in their evacuation. Unfortunately, due to stealth design, modern naval ships have few exits to the outside, i.e., to the main deck (in some

cases, only two: forecastle and flight deck). Thus, optimizing the flow of crewmembers as they evacuate a ship is even more important today than it was in the past.

If ship integrity has highest priority (for example, so the ship has time to reach shallow water and be grounded for a later rescue), this can be accommodated in the objective function. However, this specific scenario is not considered here.

C. MODELING NAVAL-SHIP EVACUATION

1. From Passenger-Ship Models To Naval-Ship Models

Despite the differences between the naval-ship and passenger-ship evacuation problems, we first look at models from the civilian world to guide our modeling approach. Mathematical models concerning human movement under emergency and non-emergency conditions have largely evolved since the work by Predtechenskii and Milinskii (1969). This work provides walking-speed formulae as functions of density, for a civilian setting, and has been used widely to gain insight into the problem.

The evacuation process for occupants of any structure, such as a building, aircraft, passenger ship or offshore platform, can be modeled using two basic approaches:

1. An optimization model searches for “optimal” routes for evacuees, who are treated as a homogenous “commodity,” i.e., individual behavior is ignored. These models are typically linear or nonlinear programs that may be viewed as network-flow models with side constraints (e.g., Chalmet et al., 1982). Normally, the objective minimizes the average evacuation time, or some similar statistic.
2. Discrete-event simulation models take individual movement and behavior into account, trying to realistically represent the paths and decisions made during the evacuation process. Behavioral rules employed by the evacuees vary greatly (e.g. Exodus, 2004). Clearly, optimizing the evacuation process is difficult to accomplish with such a model. Some models also incorporate “evacuation events” that affect the egress process, such as a person tripping, injured, etc. (e.g., Shetopal and Grubits, 1994.)

Because selecting the best possible escape routes requires optimization, we develop an optimization model of the ship-evacuation process that:

- Incorporates many features that are ignored in models of building or passenger-ship evacuation, for example, the importance maintaining a naval ship's integrity.
- Adapts data regarding the walking speeds of evacuees to a homogeneous population (although it is still derived from data on building evacuations).
- Directly incorporates the effects of impediments such as closed doors, blocked passageways and counter-movements of repair parties; no vague "safety factor" is used.
- Does not assume that everybody evacuates via primary routes. In fact, we calculate the best possible evacuation route for each "group" of crewmembers; a "group" is defined as all crewmembers occupying a given compartment or other location when the evacuation order is given.

We recommend that future studies validate our assumptions by the means of simulation, at the individual level, to determine if random events, e.g., tripping, door-opening times, are important.

2. Overview Of The Optimization Model

We model a naval ship evacuation by the means of a macroscopic optimization model. The enclosure, i.e., ship, is represented using a sparse, directed network and the population is treated as a homogenous assembly (at least at the "group" level, see Chapter III for details). The network is derived from technical and construction drawings, with (1) nodes representing compartments, closures and intersections, (2) arcs representing passages and stairways between nodes, (3) source nodes representing the compartments where crewmembers are initially located, and (4) muster nodes, connected to a super-sink node, representing mustering stations.

The model is a difficult-to-solve, nonlinear, mixed-integer program with an underlying network sub-structure. The difficulty in solving the model arises from two factors:

- The speed $s_{g,n,m}$ at which a group g of evacuees traverses an arc $a = (n, m)$ depends on the concurrent flow with other groups on the arc.
- The first group to reach a closed closure will incur a delay t_n , but subsequent groups will not directly incur that delay.

The model seeks to minimize an objective function incorporating two goals: evacuation index T , and ship integrity index I . The evacuation index is the average evacuation time of all crewmembers, while the ship integrity index reflects the number of closures remaining open after the muster phase of the evacuation. These two objectives are, to some extent, in conflict with each other; for example, opening a watertight door may speed the access to a mustering station, but it may also degrade the ships integrity. (Remark: We assume that the first group that arrives at a closed closure will open it and it will remain open afterwards, even if other groups traverse the closure).

As we explain in detail in Chapters II and III, the optimal solution to the problem is approximated by employing an iterative, heuristic algorithm that uses ideas similar to successive linear programming (e.g., Fletcher and Sainz, 1989). At each iteration, we replace nonlinear terms by estimated coefficients, add constraints to eliminate counter-flows that have been observed, and then solve the approximating mixed integer. The new solution is used again to readjust nonlinear coefficients, new constraints are added if necessary, and the process is repeated until no more adjustments are necessary.

D. THESIS OUTLINE

The rest of this thesis is organized as follows. Chapter II describes the mathematical details of our DER model for naval-ship evacuation. Chapter III explains the methodology used to solve the model approximately. Chapter IV describes the application of the model to a recently built frigate: Dynamic escape plans are compared to a static escape plan under diverse scenarios. Conclusions are drawn in Chapter VII.

Chapter VIII contains recommendations for further research. Appendices A – D contain additional information.

II. MATHEMATICAL FORMULATION

A. INTRODUCTION

This chapter develops a nonlinear mixed-integer optimization model for DER. An underlying sparse network represents the enclosure; evacuees are treated “macroscopically,” i.e., as groups of crewmembers with identical attributes.

The directed network is derived from technical and construction drawings:

- Nodes N represent compartments, closures and intersections;
- Arcs A represent passages and stairways;
- Source nodes represent the compartments where crewmembers are initially located; and
- “Muster nodes,” connected to a super-sink node, represent mustering stations.

The occupants of each compartment are treated as a single commodity in a multi-commodity flow model. The commodities are homogeneous except that all “members” of a commodity start at a common origin and are directed to a common (but initially unspecified) destination. Compartment occupancy at the time of the contingency represents supply of the commodity at the source nodes. Mustering stations represent “elastic demand” nodes, in which the demand lies between limits based on the mustering station’s capacity. To model this situation in a more standard fashion, these nodes are attached to a super-sink whose demand equals the total number of evacuees, and each connecting arc is given a capacity equaling that of the relevant mustering station. We also assume that all crewmembers that are located in a single compartment will follow a unique evacuation route.

Our model will be nonlinear because:

- The speed $s_{g,n,m}$ at which a group of evacuees g traverses an arc $a = (n, m)$ depends nonlinearly on the concurrent flow of crewmembers, in all groups, on that arc; and

- An “initial group” that must open a closure at node n incurs a delay t_n , while subsequent groups do not. We adopt a conservative assumption that the closure is not closed again.

The walking speed of pedestrians, under normal circumstances or during emergency egress, has been addressed by many authors like Predtetschenski and Milinski (1971), Fruin (1971) and Pauls (1988), but none of these authors has applied their work to a naval environment. However, more recently, the Escape and Evacuation Naval Authority of the U.K. conducted trials on two naval ships and on a damage repair instructional unit (a mockup of a naval ship) (Boxal, 2005). The data collected is intended to be used in the ship-evacuation modeling software maritimeEXODUS (Exodus, 2004) and will likely contain more representative transit-speed estimates than the ones used in this thesis. However, these data are not available at the time of our research, so we adopt the speed function recommended by the IMO for passenger ships (MSC/Circ 1033, 2002), without any age or gender corrections; see Figure 2. The speed when traversing a trunk (vertical passage), not supplied by IMO, has been estimated.

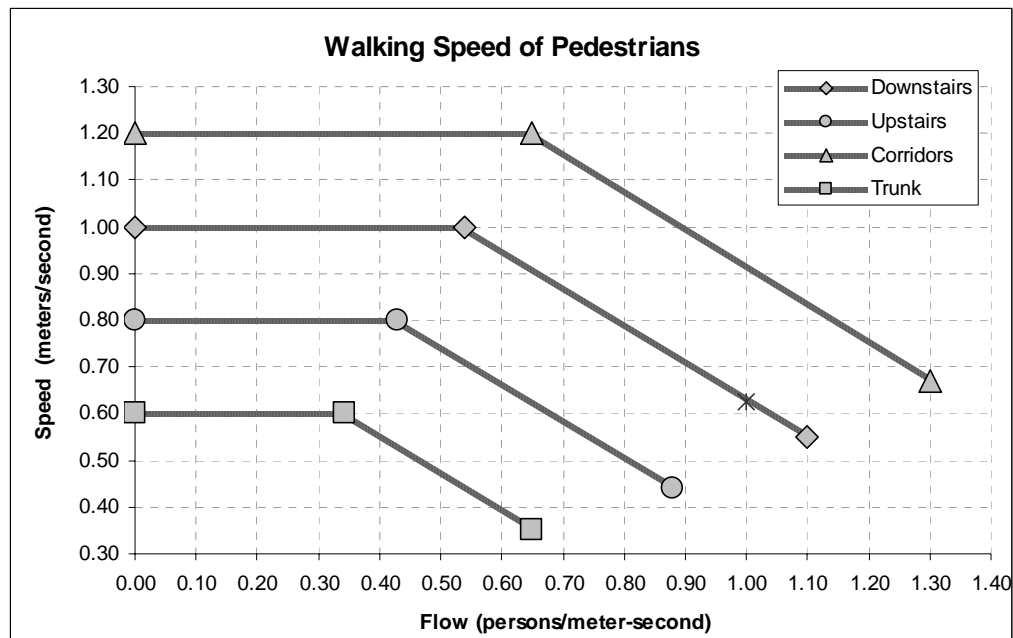

Figure 2. Walking speed of pedestrians as a function of flow (total number of persons per meter of passage section and second), in accordance with MSC/Circ. 1033.

In accordance with IMO, the speed of evacuees is a function of:

- The concurrent flow of persons traversing an arc (the number of escaping persons past a point in the escape route per unit time per unit of clear width of the route involved),
- The type of arc (e.g. passage, companionway, trunk), and
- The direction (upstairs, downstairs)

The following sections of this chapter describe the model formulation and algorithm used.

B. INDICES AND SETS OF INDICES

| | |
|--------------------|---|
| $n \in N$ | Nodes, including an artificial super-sink node, denoted n^+ |
| $g \in G$ | Groups, where each group consists of crewmembers originally located at the same compartment node |
| n_g^0 | Origin node for group g , $n_g^0 \in N$ |
| $N^M \subset N$ | Nodes representing mustering stations |
| $N^D \subset N$ | Nodes that require opening a closure for the first group that traverses the node (depends on the MCR of the ship) |
| $a = (n, m) \in A$ | Arcs, including artificial arcs $a = (n, n^+)$, for $n \in N^M$ |
| C | Set of indices for counter-flow constraints, defined as $C = \{(g, g', n, m) \mid g, g' \in G, g \neq g', (n, m) \in A, n < m \text{ and } (m, n) \in A\}$ |

Remark: The heuristic solution procedure only builds a small subset of C , “on the fly,” but the final subset guarantees that all counter-flow constraints are satisfied

C. PARAMETERS [UNITS]

c_n Capacity of muster node $n \in N^M$ [no. of evacuees]

v_g Size of group g [no. of evacuees]

$d_{n,m}$ Length of arc $a = (n, m)$ [meters]

Remark: “Length” includes correction by a “permeability factor” when n is an origin node and if the group originating there traverses (n, m) . This factor is defined in section IV.B.5

$S_{n,m}(F)$ Speed function on arc $a = (n, m)$ as a function of the total concurrent flow F on the arc (see Figure 2) [meters/second]

\hat{t}_n Time to open a closure at node $n \in N^D$ [seconds]

Remark: Depends on type of closure; see Table 3

γ_n Non-negative objective-function weight for closure at node $n \in N^D$, if any

Remark: The contribution to ship integrity of closure at node n depends on the type of closure and is normalized by the total number of initially closed closures for the specific type, which depends on the MCR

α, β Objective-function weights for trade-off between evacuation time and ship integrity, respectively [weight units]

\bar{t} Reference value used in the objective function for normalizing the evacuation time index [seconds]

Remark: We use $\bar{t} = 300$ seconds as the “target” based on the standard duration of the emergency escape breathing devices (EEBD)

r “Resolution parameter” used for deciding whether or not two groups traverse an arc concurrently [seconds]

Remark: We use $r=5$ seconds

D. DECISION VARIABLES

| | | |
|-------------|---|-----------|
| $f_{g,n,m}$ | 1 if group g traverses arc $a = (n, m)$, and 0 otherwise. | |
| $s_{g,n,m}$ | Speed of group g while traversing arc $a = (n, m)$ | [m/s] |
| | (see Figure 3) | |
| $t_{g,n,m}$ | Time when group g starts traversing arc $a = (n, m)$, if it does, and 0 otherwise | [seconds] |
| $y_{g,n}$ | 1 if group g is the first group crossing a closed closure $n \in N^D$, and 0 otherwise | |
| T | Evacuation index, calculated as the average evacuation time normalized by the reference time, \bar{t} | |
| I | Ship integrity index | |
| Z | Weighed objective function | |

E. OBJECTIVE FUNCTION AND CONSTRAINTS

(P) minimize $Z = \alpha \cdot T + \beta \cdot I$

$$\text{s.t. (1) } T = \left(\frac{1}{\sum_g v_g} \sum_{\substack{(n,m) \in A \\ m \neq n^+}} \sum_g v_g \frac{d_{n,m}}{s_{g,n,m}} f_{g,n,m} + \sum_{n \in N^D} \sum_g t_n y_{g,n} \right) \frac{1}{\bar{t}}$$

Remark: We set $d_{n,n^+} = 0, \forall n \in N^M$ and $s_{g,n,n^+} = 1, \forall g \in G, n \in N^M$

$$(2) \quad I = \sum_{n \in N^D} \sum_g \gamma_n y_{g,n}$$

$$(3) \quad \sum_{m|(n,m) \in A} f_{g,n,m} - \sum_{m|(m,n) \in A} f_{g,m,n} = \begin{cases} 1 & \text{if } n = n_g^0 \\ -1 & \text{if } n = n^+ \\ 0 & \text{if } n \in N \setminus \{n_g^0, n^+\} \end{cases} \quad \forall g \in G$$

$$(4) \quad \sum_{g \in G} v_g f_{g,n,n^+} \leq c_n \quad \forall n \in N^M$$

- (5) $f_{g,n,m} + f_{g',n,m} \leq 1 \quad \forall (g, g', n, m) \in C$
- (6) $f_{g,n,m}, y_{g,n} \in \{0,1\} \quad \forall g \in G, n \in N, (n,m) \in A$
- (7) $(\mathbf{f}, \mathbf{s}, \mathbf{t}, \mathbf{y}) \in \chi$

where χ defines, in implicit form, the relationship among decision vectors \mathbf{f} , \mathbf{s} , \mathbf{t} , and \mathbf{y} as follows:

- (7.a) Let $n \in N^D, g \in G$. Then,

$$y_{g,n} = \begin{cases} 1 & \text{if } g = \underset{g'}{\operatorname{argmin}} \{ t_{g',n,m} \mid f_{g',n,m} = 1, g' \in G, (n,m) \in A \} \\ 0 & \text{otherwise.} \end{cases}$$

- (7.b) Let $(n, m)_k = (n_k, m_k), k=1,2,\dots,K_g$, be the ordered sequence of consecutive arcs traversed by group $g \in G$. Then:

$$t_{g,n_k,m_k} = \begin{cases} 0, & \text{if } k=1 \\ t_{g,n_{k-1},m_{k-1}} + \frac{d_{n_k,m_k}}{s_{g,n_k,m_k}} & \text{if } n_k \notin N^D, k=2,\dots,K_g \\ t_{g,n_{k-1},m_{k-1}} + \frac{d_{n_k,m_k}}{s_{g,n_k,m_k}} + \hat{t}_{n_k} y_{g,n_k} & \text{if } n_k \in N^D, k=2,\dots,K_g \end{cases}$$

- (7.c) For each $(n, m) \in A$ and $g \in G$ such that $f_{g,n,m}=1$:

Let $G_{g,n,m} = \{ g' \in G \mid |t_{g,n,m} - t_{g',n,m}| < r \}$, be the subset of groups concurrent with group g to traverse arc (n, m) .

Let $F_{g,n,m} = \sum_{g' \in G_{g,n,m}} v_{g'}$ be the total flow (number of evacuees) concurrent with group g to traverse arc (n, m) .

Then, $s_{g',n,m} = S_{n,m}(F_{g,n,m}) \quad \forall g' \in G_{g,n,m}$. (Figure 3 shows a representative speed function.)

F. DESCRIPTION

The model formulated above is a nonlinear mixed-integer optimization model, with an underlying network sub-structure, which seeks to minimize an objective function based on two weighted goals reflected by the evacuation index T , and ship integrity index I .

Constraint (1) calculates the evacuation index T , as the average evacuation time over all the groups, normalized by the reference time \bar{t} . The evacuation for a single group is that group's transit time from the origin node to the sink node, plus any additional time required to open closed closures it reaches before any other group.

Constraint (2) calculates the ship integrity index I as the weighted integrity lost by closures of each type opened by the evacuees, normalized by the initial number of closed closures. Weights account for the level of watertight and airtight degradation that the opened closure causes to the ship. More degradation implies a higher weight. Door data, including weights and opening times, are specified in Appendix D.

Constraints (3) are the balance constraints for all groups and nodes. These constraints ensure that all the evacuees leave their respective origin nodes (sources) and reach some mustering station (which is connected to the super-sink).

Constraints (4) limit the number of evacuees that can reach a mustering station, based on the availability and capacity of the boats and life-rafts at each station.

Constraints (5) prohibit counter-flows, i.e., two groups moving in opposite directions on any arc. Counter-flows are unacceptable since escape signs should only point in one direction: Once configured, escape signs remain fixed during the whole evacuation process, and do not vary based on which group is traversing the arc. These constraints do not prevent two groups arriving at a node from departing in different directions, however. This may be a reasonable property if the groups arrive from different directions because they would see different signs, but is a model limitation otherwise. (Remark: None of our cases exhibits problems in this regard, but, if needed, this situation could be explicitly avoided by adding constraints and binary variables that would force a unique forward direction of travel sign at each junction).

Constraints (6) ensure flows and closure openings are binary decision variables.

Equation (7.a) determines whether or not a group is the first one traversing a node with a closed door.

Equation (7.b) calculates the time at which a given group starts traversing a given arc.

Equation (7.c) calculates the speed at which a given group traverses an arc, based on the approximate number of evacuees that share that arc during the same time interval.

III. SOLUTION METHODOLOGY

A. DESCRIPTION

We approximate the optimal solution to (P) by employing an iterative heuristic algorithm that uses ideas similar to successive linear programming (e.g., Fletcher and Sainz, 1989). In each iteration we replace (P) by an approximating mixed-integer linear problem. In essence, the approximating problem replaces non-linear terms (such as $1/s_{g,n,m}$ in the objective function) and non-explicit constraints (such as those arising from relationships in (7)) by approximated values derived from a post-process of the tentative solution to a previous approximating problem. We also ignore counter-flow constraints and only add to the approximating problem those needed in order to avoid inconsistencies in intermediate solutions. Newly generated solutions are used again to readjust terms for the next approximating problem, and the process is repeated until no more adjustments are necessary. Unlike standard sequential linear programming, we neither add penalty terms nor enforce trust regions. This has not been necessary, at least in our computational experience, for the process to converge, reasonably quickly, to a feasible solution. The procedure is formally defined here:

Algorithm: Ship Evacuation

| | | |
|----------------------|-------|---|
| <u>Step 0</u> | Set | $\hat{y}_{g,n}^0 := 0, \forall g \in G, n \in N^D$ |
| Initialization | | $\hat{s}_{g,n,m}^0 := S_{n,m}(v_g), \forall g \in G, (n,m) \in A$ |
| | | $C^0 := \emptyset$ |
| | | $C := C^0$ (set of counter-flow valid inequalities) |
| | | $i := 0$ (iteration counter) |
| <u>Step 1</u> | Solve | $(P^i) \min Z = \alpha \cdot T + \beta \cdot I$ |
| Optimization | | $s.t. \quad (1)-(6)$ |
| | | $(8)-(9)$ |

where (5) is only applied to elements in the updated set C

and (8) – (9) are as follows:

$$(8) s_{g,n,m} = \hat{s}_{g,n,m}^i, \forall g \in G, (n, m) \in A$$

$$(9) y_{g,n} \geq f_{g,n,m}, \forall g \in G, n \in N^D, (n, m) \in A \mid \hat{y}_{g,n}^i = 1$$

Assume (P^i) yields $\mathbf{f}^i, \mathbf{s}^i, \mathbf{y}^i, Z^i$

Step 2

Post-Process

(2.a) Compute all $\hat{t}_{g,n,m}^i$ using (7.b) and update $\hat{s}_{g,n,m}^i$ and $\hat{y}_{g,n}^i$ with values consistent with (7.a)-(7.c). See details below.

Calculate the adjusted \hat{Z}^i .

If updates on $\hat{s}_{g,n,m}^i$ and $\hat{y}_{g,n}^i$ are made, set

changes := true

otherwise set

changes := false

(2.b) Update counter-flow set for the next iteration:

$$C^{i+1} := C^i \cup \left\{ (g, g', n, m) \mid f_{g,n,m}^i \cdot f_{g',m,n}^i = 1 \right\}$$

$$C := C^{i+1}$$

Step 3

Convergence

If *changes := false* and $C^{i+1} := C^i$ then STOP:

A heuristic solution has been found: $(\hat{\mathbf{f}}^i, \hat{\mathbf{s}}^i, \hat{\mathbf{t}}^i, \hat{\mathbf{y}}^i)$.

The objective value for this solution is \hat{Z}^i , and a bound on the best possible solution is Z^0 .

Otherwise, set $i := i+1$ and return to Step 1.

The updates in the post-process step constitute the algorithm's foundation. Since we do not know, a priori, the number of crewmembers that will traverse an arc, we initiate the algorithm by setting the speed of any group g traversing an arc $a=(n,m)$ to the maximum possible speed, $s_{n,m} = S_{n,m}(v_g)$ (see Figure 3). This assumes there is no other concurrent group at the time g traverses the arc, i.e., it is an optimistic assumption. We also set to zero all the decision variables $y_{g,n}$, i.e., we assume the group encounters all closures open. Under these "ideal" conditions the objective value obtained after this first iteration, Z^0 , is a lower bound on the optimal solution to (P) .

As soon as the solution to problem (P^0) is available, a post-process determines:

- Concurrent flow: groups that traverse the same arc near-simultaneously, under these "ideal" conditions;
- Counter flow: groups that traverse an arc in opposite directions;
- First group to open a closure.

To account for these aspects we must calculate the actual time at which each group traverses an arc and/or reaches a node on its way to a mustering station. Our static network fails to capture the dynamic nature of our problem. Ford and Fulkerson (1958) proposed transforming a static network into a dynamic one by replication, leading to well-known "time-phased networks." However, such a network would notably increase our model's size, yet it would not completely eliminate the nonlinearity associated with the concurrent flow on the arcs. Our approach post-calculates the time at which each group traverses nodes and arcs on its route by backtracking from the mustering station to the origin node.

We assume that two groups, g and $g' \neq g$, that are traversing an arc $a = (n,m)$ constitute a near-simultaneous flow if the following conditions arise:

$$t_{g,n,m} < t_{g',n,m} \text{ and } t_{g',m,p'} < t_{g,m,p},$$

where p is the next node in the path for group g and p' is the same for g' .

This calculation is performed incrementally for all groups traversing every arc. Each group's speed is calculated in (7.c) based on the total flow (number of evacuees) concurrent with group g to traverse arc (n,m) .

Two or more groups of crewmembers may cross a closure but only one can be the first one (identified as in (7.a)) to open that closure. The heuristic scheme accounts for this fact by charging the “first group” with a delay in the objective function should the group persist to use that closure at the next iteration (constraint (9)).

Finally, the post-process analyzes possible counter-flows. Counter-flows are unacceptable because, once configured, escape-route signs remain fixed during the whole evacuation process; they do not vary based on which group is traversing an arc. Since, in practice, the majority of counter-flow constraints (5) will be inactive, we only enforce them as needed.

Iterations continue until the following two conditions are met:

- There is no significant variation between the values produced by the simplified model, $\mathbf{s}^i, \mathbf{y}^i$, and the post-processed values, $\hat{\mathbf{s}}^i, \hat{\mathbf{y}}^i$.
- There is no counter-flow.

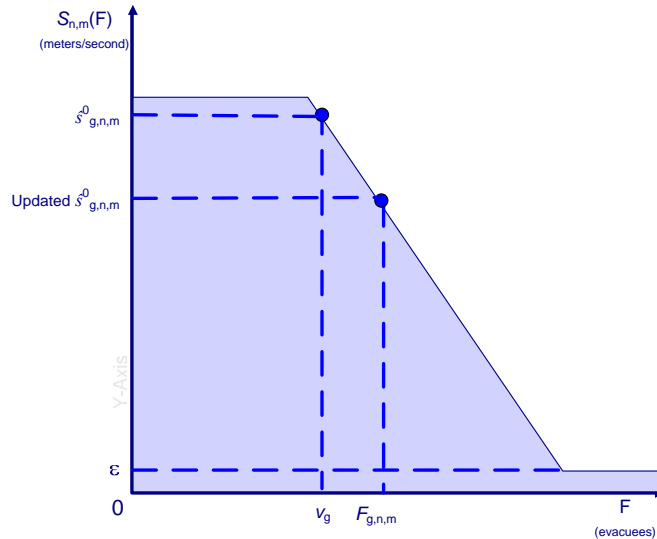

Figure 3. Representative walking speed as a function of concurrent flow on arc (n,m) . A minimum speed ϵ is used to avoid by-zero divisions. Initially, the algorithm uses the maximum possible speed for a group g of size v_g . When total concurrent flow, $F_{g,n,m}$, on the arc is realized, speed is updated.

IV. CASE STUDY

A. INTRODUCTION

The DER model introduced in the previous chapter has been evaluated on a recently built 5,800 Ton frigate, the F-101 ÁLVARO DE BAZÁN (see Figure 4). This is the first of four medium-sized multi-purpose frigates ordered by the Spanish Navy and built by Izar shipyard. The last of these frigates is expected to be commissioned in 2007.



Figure 4. F-101 ÁLVARO DE BAZÁN.

The main particulars of this class are:

- Propulsion: Two General Electric LM 2500 gas turbines, two caterpillar 3600 diesel engines
- Shafts: 2
- Length: 147 m
- Beam: 18.6 m
- Draught: 4.75 m
- Displacement: 5,802 tons full load
- Speed: 29+ knots
- Range: 5,000 nm
- Crew: 245 (35 officers)

Ships are designed and built using technical drawings or “blueprints” created with computer-aided design software, and various versions of the drawings are created as the ship goes through the design process. The network used for DER modeling in this thesis is based on the final technical drawings for the ÁLVARO DE BAZÁN (Figure 5).

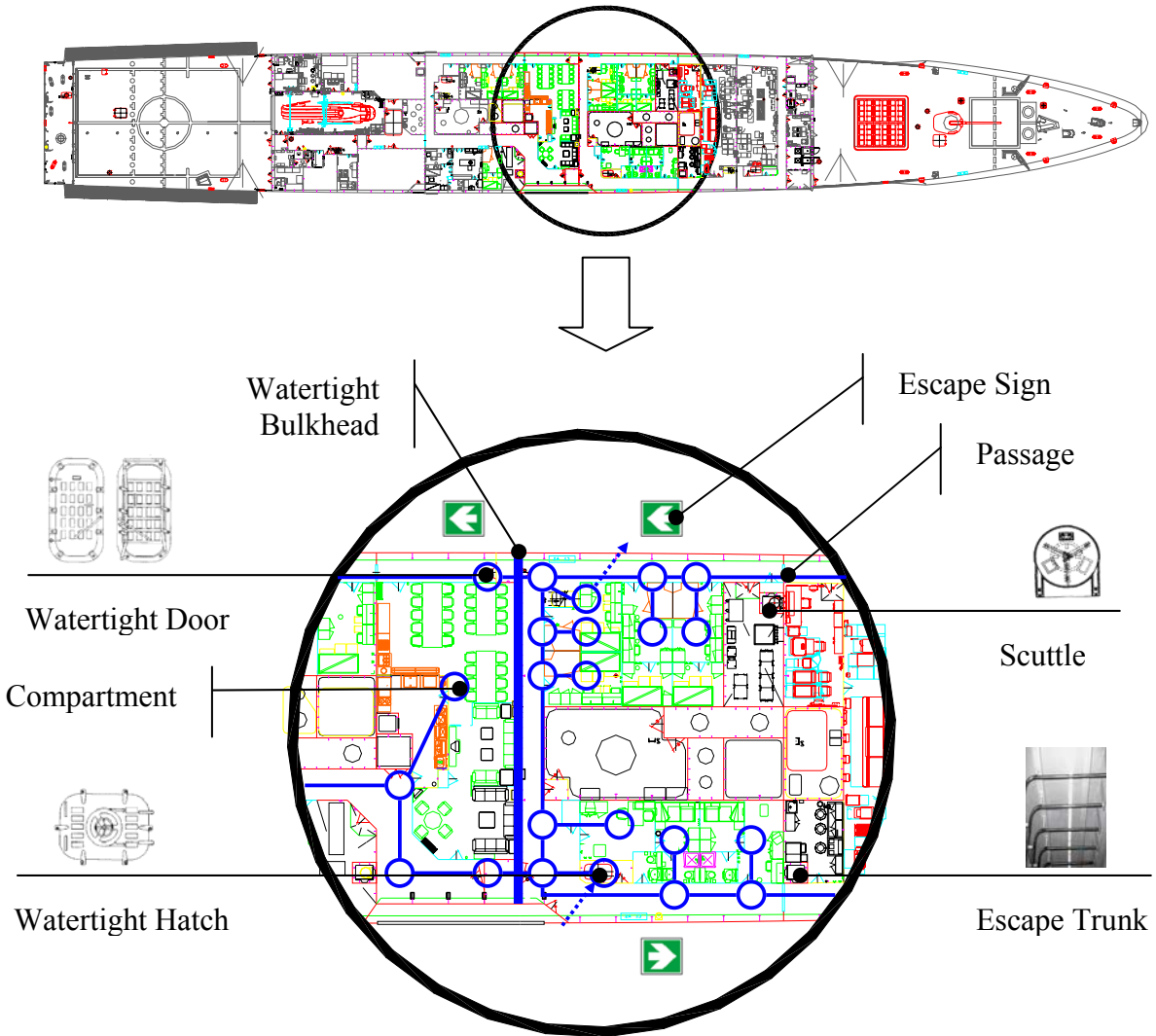

Figure 5. Building the DER network for the ÁLVARO DE BAZÁN from technical drawings. The figure represents most of the elements considered in building the DER network.

B. NODES

Our DER network has 639 nodes representing compartments, closures, intersections and mustering stations on seven decks, three below the main deck, and three above it (Table 2).

| Below Main Deck | Number of Nodes | Above Main Deck | Number of Nodes |
|---------------------------|------------------------|------------------------|------------------------|
| <i>Deck 4</i> | 41 | <i>Level 01</i> | 64 |
| <i>Deck 3</i> | 124 | <i>Level 02</i> | 41 |
| <i>Deck 2</i> | 233 | <i>Level 03</i> | 3 |
| <i>Deck 1 (Main Deck)</i> | 133 | | |

Table 2. Number of nodes per deck or level.

We collect all relevant information from technical drawings and consolidate it in an Excel spreadsheet (Figure 6), which also allows us to implement embedded validations in order to avoid clerical errors. Node attributes are as follows:

- Node ID: a unique identifier of the node;
- Name: node description;
- Type: For example, watertight door;
- MCR Mark: Used to determine if a closure is initially closed or not, depending on the relevant MCR;
- “X,Y,Z” Coordinates: Node location with respect to a Cartesian reference system;
- Supply: Number of crewmembers, if any, originally located at the node for each possible situation (general quarters, watch and port)

These attributes are explained in detail in the remainder of this section.

| Node ID | Type | MCR Mark | Name | X | Y | Z | GQ | Watch | Port |
|-------------|--------|----------|-------------------|--------|-------|-------|-----|-------|------|
| | | | | | | | 101 | 110 | 62 |
| 2-215-4-T2 | T2 | Null | Trunk | 129.00 | -2.28 | 7.781 | 0 | 0 | 0 |
| 2-214-2-WTD | WTD | Y | Fore Peak | 128.00 | -1.50 | 7.754 | 0 | 0 | 0 |
| 2-211-0-E | Source | Null | Windlass Room | 126.83 | 0.00 | 7.722 | 16 | 8 | 0 |
| 2-209-2-WTS | WTS | X | Scuttle | 125.38 | -1.54 | 7.683 | 0 | 0 | 0 |
| 2-208-2-WTD | WTD | X | Subdivision | 124.80 | -2.92 | 7.668 | 0 | 0 | 0 |
| 2-203-4-T | T | Null | Access Trunk | 121.83 | -3.44 | 7.587 | 0 | 0 | 0 |
| 2-203-2-D | NTD | X | Non Tight Door | 121.82 | -2.81 | 7.587 | 0 | 0 | 0 |
| 2-202-1-C2 | C2 | Null | Repair Station #6 | 120.89 | 0.96 | 7.562 | 16 | 0 | 0 |

Figure 6. Node data sheet. Information relative to network nodes is consolidated in a spreadsheet

1. Node ID

Node ID contains four components: deck number, station number, side number and usage letter. This convention is similar to the Compartment Designation Numbering System (CDNS) which was established and has been in use by the U.S. Navy since 1949 (Compartment Letters for Ships, 2005). Those who are familiar with the CDNS can easily identify a node and locate its position onboard. This convention is explained in detail in Appendix C.

2. Type

The nodes of the DER network represent one of the following:

a. Compartments

The ship is divided into compartments by means of horizontal divisions called “decks,” and vertical divisions, which can run transversely or longitudinally, called “bulkheads.” Watertight bulkheads are spaced at appropriate intervals and extend from the keel to the main deck and from side to side. Some bulkheads and decks have the important mission of guaranteeing the floatability of the ship when damage occurs or are built to ensure adequate structural strength. Compartments are important to our model because we assume crewmembers are located in these berthing compartments, repair stations, magazines, the combat information center, the bridge, etc. Some other compartments are never occupied, which is the case of tanks and void spaces, or they are

rarely visited, such as stores; we ignore such compartments when building the DER network.

The number of people occupying a compartment is variable and depends on the condition ordered by the commanding officer, which is uniquely defined in the shipboard organization book. This topic will be addressed in paragraph 5 below.

b. Closures

For the purpose of this study, we reduce the number of closure types to seven. (See Appendix D for a detailed discussion of types of closures that can be found onboard of naval ships.). Heavier closures are more difficult to open than lighter ones. We estimate the time required to open each type of closure as indicated in Table 3. The ordered MCR dictates which closures are initially opened or closed (see Table 1).

| Type | Symbol | Time to Open (seconds) |
|---------------------------|---------------|-----------------------------------|
| <i>Watertight Door</i> | WTD | 20 |
| <i>Watertight Hatch</i> | WTH | 30 |
| <i>Watertight Scuttle</i> | WTS | 25 |
| <i>Airtight Door</i> | ATD | 10 |
| <i>Airtight Hatch</i> | ATH | 15 |
| <i>Airtight Scuttle</i> | ATS | 10 |
| <i>Non-tight Door</i> | NTD | 5 |

Table 3. Estimated time to open a closure by the first group of evacuees.

c. Mustering Stations

Muster nodes represent mustering stations, which are the locations onboard where the crew assembles and waits for the order to embark on life-rafts. A

mustering station has a limited capacity that depends on the number of life-rafts mounted in its vicinity. We assume ÁLVARO DE BAZÁN has three mustering stations, the forecastle, flight deck and boat deck, as shown in Figure 7.

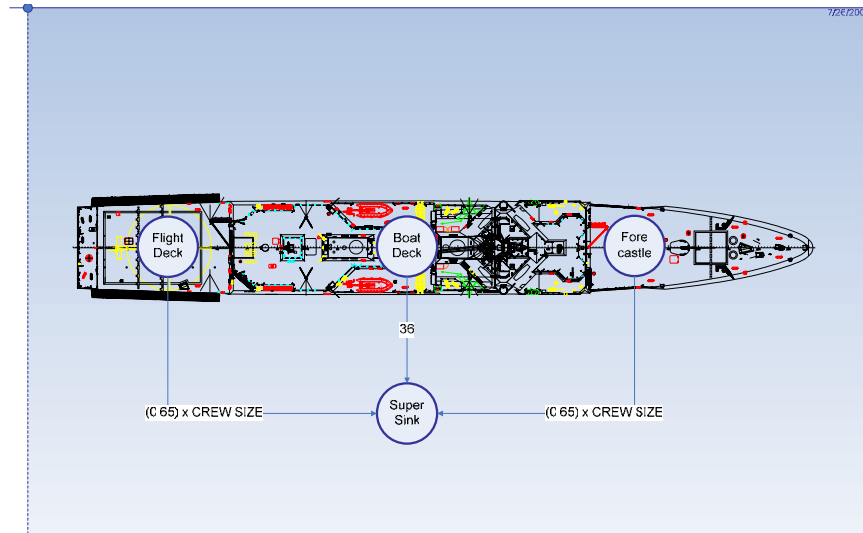

Figure 7. Mustering stations on the ÁLVARO DE BAZÁN.

The mustering station on the boat deck is limited to 36 people because this is the maximum capacity of the two rigid-hull inflatable life-boats situated on this deck. The rest of the crew musters on the forecastle and the flight deck with some flexibility: We allow at most 65% of the crew to muster at either station. This assumption needs to be further validated and checked against the actual distribution of life-rafts.

3. Material Condition Of Readiness

The MCR dictates whether or not a closure is initially open. A full description can be found in the Appendix A.

4. Coordinates

Coordinates X , Y , Z represent the position of the node with respect to the specified coordinate system. We adopt the standard coordinate system where the origin is the intersection of the aft perpendicular (AP), baseline (BL) and centerline (CL) (see Figure 8). The baseline is used as the longitudinal axis, the x -axis of the system of coordinates in which nodes are defined, and it is positive moving forward. The y -axis is

transversal and positive to starboard. The z-axis is vertical and positive upwards. This coordinate system is different from the system used in the United States, where the origin is located at the FP and is positive moving aftwards.

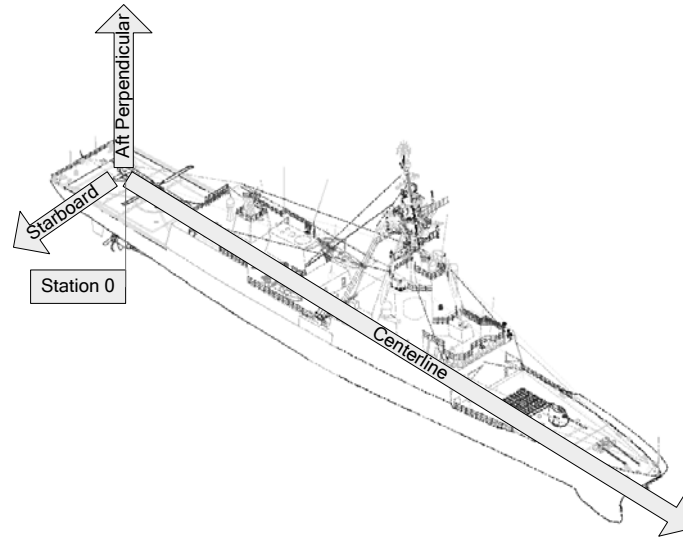

Figure 8. Coordinate reference system for the ÁLVARO DE BAZÁN.

5. Source Nodes

The initial distribution of crewmembers across compartments depends on the crew distribution ordered and is uniquely determined by the ship's organization book. Each member of a naval ship crew is assigned to a unique station for each situation. Battle bills, i.e., the lists of stations that must be manned during battle and other conditions, vary among the world's navies, naval ship classes and doctrines. However, they usually cover two main categories: wartime and peacetime. Each category subdivides into conditions I to V, which are ordered by the CO. Of all the possible conditions for our frigate, we select the following three crew distributions as most representative:

- **General Quarters:** equivalent to Condition I. The ship is in battle condition and all crewmembers are located at their combat stations.
- **Watch:** equivalent to Conditions III and IV. We assume that one third of the crew is located in control and weapons stations, one third is resting in

their cabins and the remaining third is working in offices or relaxing in living rooms.

- **Port:** All crewmembers but the guard are resting in their cabins or berthing rooms. This is a plausible scenario, especially at night and when harbored in a non-home port.

A detailed table of crew distribution can be found in the Appendix B. Table 4 summarizes totals by deck and level for each of the three conditions considered.

| Deck Number | General Quarters (no. of crew) | Watch (no. of crew) | Port (no. of crew) |
|--------------------|---|--------------------------------|-------------------------------|
| <i>4</i> | 20 | 9 | 0 |
| <i>3</i> | 5 | 59 | 167 |
| <i>2</i> | 101 | 110 | 62 |
| <i>1</i> | 34 | 23 | 14 |
| <i>01</i> | 59 | 32 | 0 |
| <i>02</i> | 20 | 9 | 2 |
| <i>03</i> | 6 | 3 | 0 |

Table 4. Crew distribution by deck and condition on the *ÁLVARO DE BAZÁN*.

By the above, we assume that we know the exact number of crewmembers in a compartment. However, we do not know their exact positions within the compartment. For simplicity, we account for this by using a correction factor, called “permeability,” which increases the distance from the center of the compartment to the exit, based on how difficult it is to exit the compartment for evacuees: For example, engine rooms are packed with equipment, and this makes access to an exit harder than in sparsely equipped living rooms.

C. ARCS

The DER network for the ÁLVARO DE BAZÁN contains 1,435 arcs representing passages, trunks and companionways.

Crewmembers move from one compartment to another on the same deck through passages whenever the deck is not interrupted by a watertight bulkhead. Passages on naval ships, where aesthetical considerations are neglected, differ from corridors on passenger ships: They tend to be narrower and full of equipment. Companionways, or ladders, lead from one deck level to another, and some of them require opening a hatch.

Escape trunks, as shown in Figure 9 are direct connections between lower compartments like engine rooms and the main deck. They are accessible through a watertight door and have special bars to facilitate climbing.

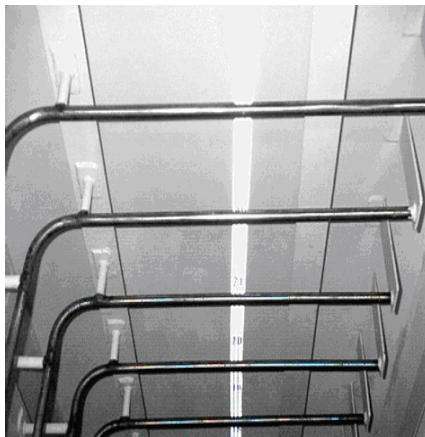

Figure 9. Looking down an escape trunk.

The following information is collected from technical drawings for our ship (Figure 10):

- *Width* is the horizontal measure taken perpendicular to the length of the arc;
- *Permeability*, increments the Cartesian distance between a node representing a compartment and the exit node based on the difficulty to find the exit of the space;
- *Type*, represents the kind of arc. We consider five types of arcs: passages, engine-room corridors, companionways, escape trunks (which lead

upward from the engine room) and vertical trunks. The speed of crewmembers when traversing an arc depends on the type of arc, among other factors.

- *Activity*, takes the value 1 if the arc can be used (for example, it is not blocked by fire) and 0 otherwise; this is a control field and it is not explicitly derived from the blue prints.

| n | m | Active | Width | Perm | Type |
|------------|------------|--------|-------|-------|------|
| 1-150-3-T | 1-147-1-T | 1 | 1.65 | 1.000 | T |
| 1-147-1-T | 1-150-3-T | 1 | 1.65 | 1.000 | T |
| 1-157-1-T | 1-157-2-T | 1 | 1.20 | 1.000 | T |
| 1-157-2-T | 1-157-1-T | 1 | 1.20 | 1.000 | T |
| 1-161-1-C2 | 1-158-2-D | 0 | 100 | 1.070 | T |
| 1-158-2-D | 1-161-1-C2 | 1 | 100 | 1.070 | T |
| 1-158-2-D | 1-157-2-T | 1 | 0.66 | 1.000 | T |
| 1-157-2-T | 1-158-2-D | 0 | 0.66 | 1.000 | T |
| 1-157-2-T | 1-157-4-T | 1 | 1.20 | 1.000 | T |
| 1-157-4-T | 1-157-2-T | 1 | 1.20 | 1.000 | T |

Figure 10. Arc data.

Some models (Pauls, 1984), including ours, use the “effective” width of the arc instead of the total width. In order to accommodate lateral body sway and assure balance, persons moving through the escape routes must maintain some clearance from walls and/or other fixed items (e.g., handrails, fixed seats, etc.). The effective width of an arc is the clear width, i.e., the width after being reduced by the sum of the clearances. For the naval-ship problem, we adjust for structural elements such as stiffeners or beams to obtain the effective width

V. TEST SCENARIOS

A. SCENARIO OVERVIEW

Naval ships such as the *ÁLVARO DE BAZÁN* are complex vessels intended for many different missions. Anticipating all possible scenarios leading to evacuation is impossible. Consequently, we limit our analysis to demonstrate the benefits of employing DER to a subset of select scenarios, each defined by three factors:

- Crew Distribution: General Quarters, Watch or Port,
- Material Condition: ZEBRA, YOKE or XRAY, and
- Damage: Ship damage (if any).

First, escape routes are configured during the normal operation phase, even before any threat is known or damage has taken place. Accordingly, we start analyzing the most significant scenarios where the ship remains intact (Table 5). Even in the absence of external damage to the ship, an evacuation may be required, for example, because of fire in the engine room.

| | | Crew distribution | | |
|--------------------|-------|-------------------|-------|------|
| | | General Quarters | Watch | Port |
| Material Condition | ZEBRA | Yes | No | No |
| | YOKE | No | Yes | No |
| | XRAY | No | No | Yes |

Table 5. Intact-ship scenarios: Three cases analyzed.

Together, the general-quarters crew distribution and ZEBRA MCR represent a scenario in which all crewmembers are at their combat stations and the ship has most of its closures shut. On the other hand, a port and XRAY condition has most of the crew resting in cabins and berthing, and the ship integrity is most relaxed. (Crew distributions and doors initially closed by MCR are specified in Appendices B and D, respectively.)

Second, we adapt our data to represent ship-damage scenarios: Speed is reduced on partially blocked arcs (for example, on arcs used by damage parties or filled with smoke). Impassable arcs (for example, those destroyed by fire after the impact of a missile) are explicitly removed from the network. We assume damage scenarios for our frigate similar to those experienced by the USS STARK and the USS COLE.

Finally, we demonstrate the utility of our model during the design stage by analyzing two design alternatives: an additional forecastle exit and an increased passage width.

In all scenarios, our DRE model (P) assumes maximum physical capacities at the mustering stations based on life-raft availability. Unless otherwise specified, we assume a maximum capacity of 119 crewmembers (65% of the total crew) at either the forecastle or the flight deck stations, whereas the boat deck station has a fixed capacity of 36 crewmembers. (Our model could be used during the design phase of the ship to determine a life-raft distribution that accommodates a flexible DER, but for now we assume that the capacities are as given.)

The weights α and β used in the model's objective function are based on the relative importance given to evacuation time T and ship integrity I , respectively. In all the cases studied, we assume that $\alpha = 2/3$ and $\beta = 1/3$. Thus, our objective Z (to be minimized) is the compound index $Z = 2/3 T + 1/3 I$. We compare the values of T , I and Z (among other parameters) for DER and static routes. Static routes are emulated in our model by fixing the $f_{g,n,m}$ variables in accordance with the technical drawings for our frigate. More specifically, we disable transit in a direction that conflicts with the static sign whose direction is given in the drawings.

In the remainder of this chapter we show computational results for each of the above scenarios. The heuristic algorithm presented in Chapter II has been implemented using the XPress optimization suite (Dash, 2004), in Mosel 1.4.1 language, with Optimizer version 15.25.03 as the solver, on a Dell Inspiron 8600 Pentium M computer running at 1.6 GHz with 512 Mb of random access memory. This software has a graphical environment to display results on the computer screen, but with limited capabilities. Therefore, we have created also created a schematic representation of the

most important decks (Decks 1 and 2 and Level 01) using Microsoft Visio (Microsoft, 2003).

B. INTACT-SHIP SCENARIOS

Table 6 shows that DER improves the evacuation index by between 19% and 26% in the intact-ship scenarios. These improvements result from improvements in both evacuation time and ship integrity (Table 7).

| | General Quarters | | Watch | | Port | |
|--------------------------|------------------|---------|--------|---------|--------|---------|
| | Static | Dynamic | Static | Dynamic | Static | Dynamic |
| Objective Index Z | 0.579 | 0.428 | 0.455 | 0.339 | 0.326 | 0.262 |
| Improvement | | 26.1% | | 25.5% | | 19.6% |

Table 6. Objective-function comparison for intact ship scenarios.

Average evacuation time following DER is up to 20% less than when using static signs. The improvement is not as significant under the general-quarters scenario, which may indicate that the static escape routes have been planned for this condition.

The time of the last group of evacuees, calculated by post-processing the solution, is also up to 30% less using DER. This result is, to some extent, unexpected, because our model does not attempt to minimize this value explicitly. (Remark: Table 7 also specifies the original location of last the group of evacuees. Our labeling convention follows standard nomenclature that is explained in Appendix C.)

| | General Quarters | | Watch | | Port | |
|------------------------------|------------------|------------|-----------|------------|------------|-----------|
| | Static | Dynamic | Static | Dynamic | Static | Dynamic |
| Mean Evac. Time (sec) | 64 | 57 | 70 | 59 | 70 | 56 |
| Improvement | | 10.9% | | 15.7% | | 20.0% |
| Time Last Group (sec) | 143 | 106 | 131 | 106 | 115 | 80 |
| Improvement | | 25.9% | | 19.1% | | 30.4% |
| Last Group | 4-141-0-E | 03-158-0-C | 4-141-0-E | 03-158-0-C | 2-130-2-L1 | 3-32-1-L2 |

Table 7. Evacuation time comparison for intact-ship scenarios.

The ship integrity is also enhanced by using DER (Table 8): The watertight index of the ship is improved by opening, in some cases, up to 20 watertight doors fewer (25%) than in the static case. The airtight index is also improved.

The improvements over static routes are achieved by changing the direction of select escape signs. Figures 11-13 depict these changes on schematics of Deck 1, Deck 2 and Level 01. White arrows indicate escape signs for static routes that have changed the direction, while green arrows are those that remain invariable. Solid dots represent closed closures and dimmed dots represent those closures that were opened in the static case but remain closed for the dynamic case.

| | General Quarters | | Watch | | Port | |
|----------------------------|---|---------|--------|---------|--------|---------|
| | Static | Dynamic | Static | Dynamic | Static | Dynamic |
| Watertight Index | 0.394 | 0.284 | 0.440 | 0.178 | 0.040 | 0.022 |
| Improvement | | 27.9% | | 59.5% | | 45.0% |
| Airtight Index | 0.392 | 0.317 | 0.330 | 0.302 | 0.061 | 0.060 |
| Improvement | | 19.1% | | 8.5% | | 1.6% |
| | Number of closures: opened by the evacuees / initially closed | | | | | |
| Watertight Doors | 79/87 | 59/87 | 68/75 | 55/75 | 21/47 | 12/47 |
| Watertight Hatches | 20/22 | 19/22 | 19/22 | 19/22 | 0/1 | 0/1 |
| Watertight Scuttles | 14/23 | 4/23 | 17/23 | 4/23 | 6/23 | 0/23 |
| Airtight Doors | 37/46 | 32/46 | 42/46 | 31/46 | 0/0 | 0/0 |
| Airtight Hatches | 5/6 | 6/6 | 6/6 | 5/6 | 0/0 | 0/0 |
| Non-tight Doors | 21/91 | 11/91 | 73/85 | 68/85 | 65/85 | 61/85 |

Table 8. Ship integrity comparison for intact-ship scenarios.

Finally, Table 9 summarizes the total number of crewmembers that muster at each of the three assembly stations.

| | General Quarters | | Watch | | Port | |
|--------------------|------------------|---------|--------|---------|--------|---------|
| | Static | Dynamic | Static | Dynamic | Static | Dynamic |
| Flight Deck | 73 | 91 | 118 | 132 | 145 | 141 |
| Boat Deck | 35 | 35 | 36 | 36 | 7 | 20 |
| Forecastle | 137 | 119 | 91 | 77 | 93 | 84 |

Table 9. Number of crewmembers that assemble at each mustering station for intact-ship scenarios.

We notice that the total numbers of evacuees by mustering station are similar in the port scenario for both static and dynamic routes. In the general-quarters and watch scenarios, DER increases the use of the flight deck by approximately 25% and 12%, respectively.

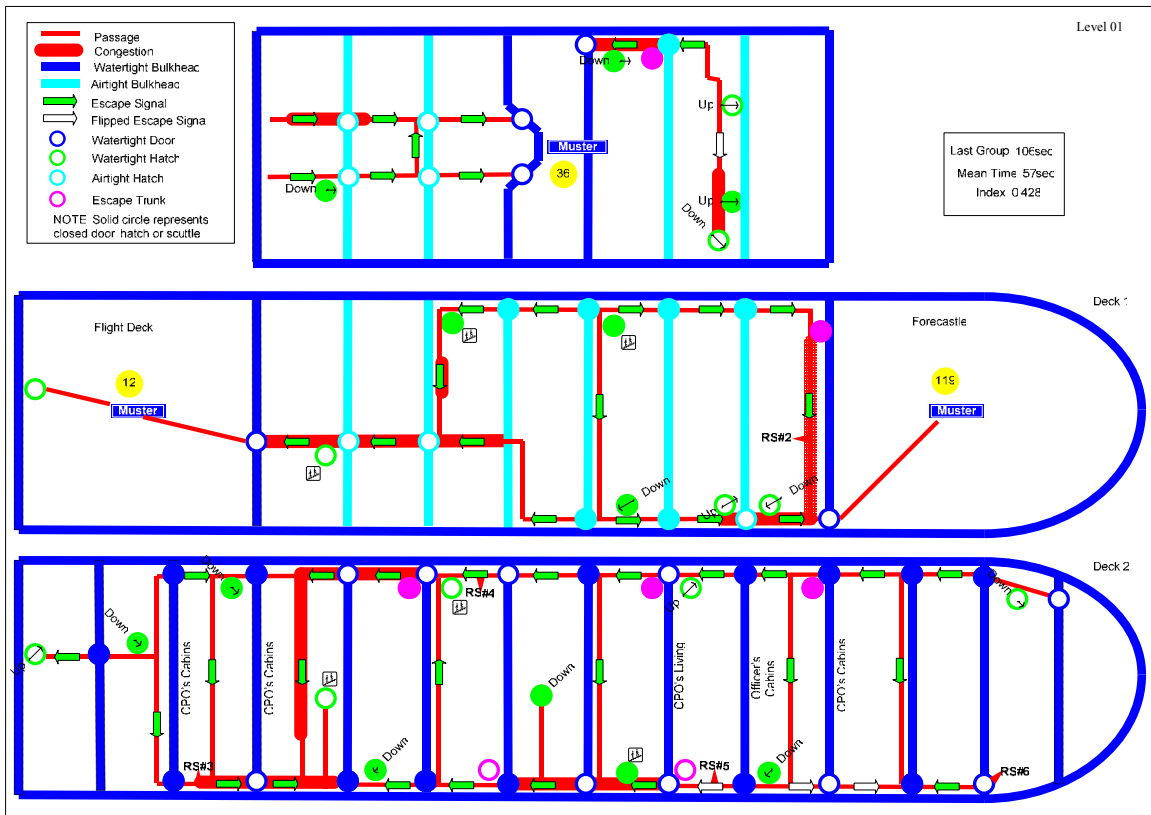

Figure 11. Comparing dynamic and static escape routes for intact-ship scenarios and general quarters condition.

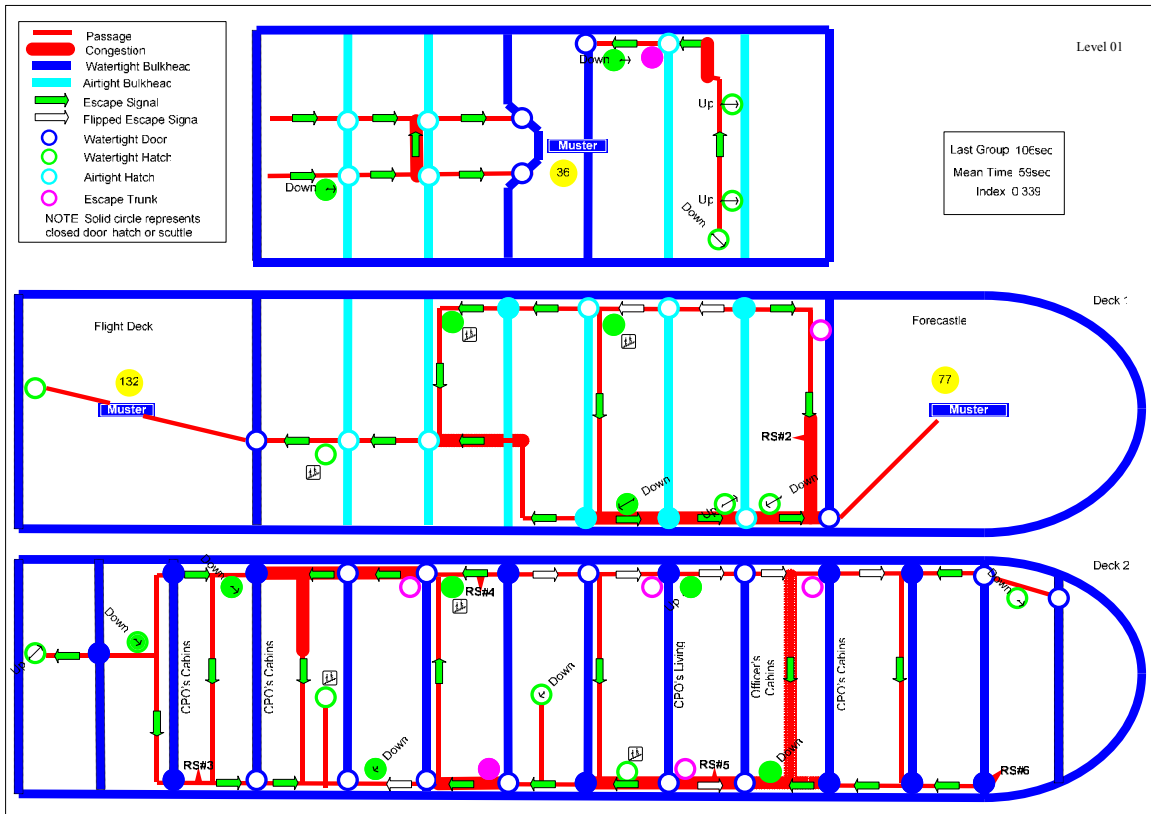

Figure 12. Comparing dynamic and static escape routes for intact-ship scenarios and watch condition

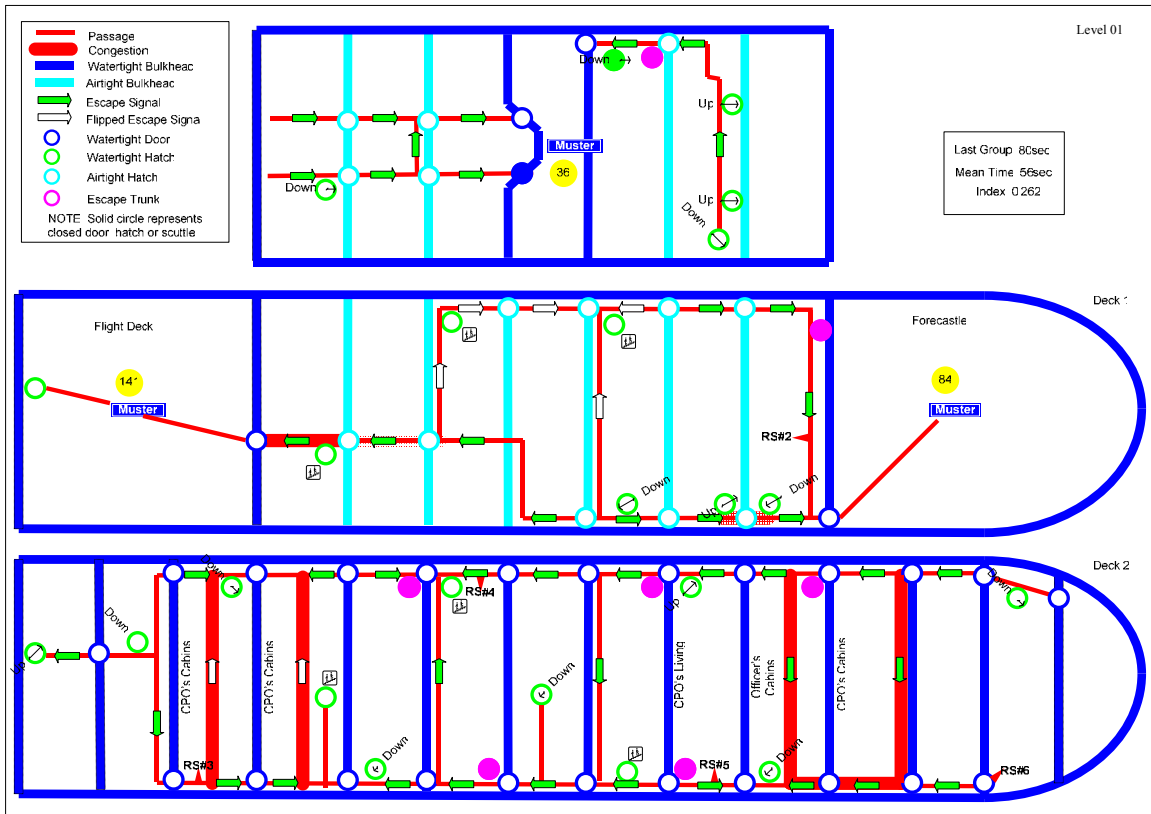

Figure 13. Comparing dynamic and static escape routes for intact-ship scenarios and port condition

Finally, we observe a clear preference of the crewmembers manning engine rooms to evacuate using escape trunks: In the general-quarters and watch scenarios, all crewmembers exit the engine rooms by escape trunks, which is a desirable outcome. Escape trunks play an important role in the evacuation process because they offer a fast and protected egress from spaces located in lower decks, without significant watertight degradation. They may also protect evacuees against fire and smoke. Remark: Escape trunks in naval ships may be viewed similarly to protected elevators in high buildings (Pauls, 2005).

C. DAMAGED-SHIP SCENARIOS

“Damaged-ship scenarios” are characterized by a damage location and the extent to which passages and closures are disabled. Damage-control (repair) parties play an important role in these scenarios because they are responsible for salvaging the ship and/or recovering its combat capability. All ships have at least one damage-control repair station (DCRS), but three or more is common on large ships. DCRSs are strategically located throughout the ship; they contain equipment used by repair parties and serve as control points for those parties.

From the point of view of our DER model, we are interested in facilitating the tasks of repair parties, especially by avoiding counter-flow of evacuees through the passages that lead repair parties to damaged areas. Of course, we also wish to avoid flow in the same direction, if possible. In any case, the use by evacuees of passages required by repair parties is penalized by decreasing the evacuees’ walking speed with respect to that given by our baseline speed functions $S_{n,m}(F)$.

Next, we analyze two examples of damage to our case-study frigate. The damage scenarios are based on two recent attacks on the U.S. frigates, USS STARK and USS COLE.

1. USS STARK Case

We consider a scenario in which our frigate receives an impact similar to that received by the USS STARK in 1991 (Wikipedia, 2005). We make these additional hypotheses to build the scenario:

- Crew Distribution: General Quarters or Watch. (“Port” does not apply because the USS STARK was at sea at the time of the attack.)
- Material Condition: ZEBRA or YOKE, respectively. (The XRAY condition does not apply because the USS STARK was engaged in war operations at the time of the attack.)
- Damage: Passages and closures located on Decks 2, 1 and Level 01, on the bow port side, are made impassable. Passages from the Repair Station #5 to the damaged area are discouraged by significantly reducing the walking speed of evacuees traversing these arcs.

Compared to static escape routes, the DER improves the evacuation-process index by approximately 25% in both scenarios; see Table 10. The mean evacuation time is reduced by 9% or 20%, depending on the scenario. Ship integrity, which is key in this scenario, is not compromised; in fact, just the opposite occurs: The level of integrity improves significantly, 47% or 60%. However, the static-route solution is 10% better than the dynamic solution with respect to the evacuation time for the last group of evacuees under the general-quarters scenario. This can be attributed to the fact that the DER model does not optimize the time of the last evacuee. Nonetheless, for the watch scenario, the time of the last evacuee is significantly better (32%) using DER.

| | General Quarters | | Watch | |
|-----------------------------------|---|--------------|--------------|--------------|
| | Static | Dynamic | Static | Dynamic |
| Objective Index | 0.588 | 0.454 | 0.529 | 0.393 |
| Improvement | | 22.8% | | 25.7% |
| Mean Evacuation Time (sec) | 66 | 60 | 87 | 70 |
| Improvement | | 9.1% | | 19.5% |
| Time of Last Group (sec) | 143 | 158 | 397 | 270 |
| Improvement | | -10.5% | | 32.0% |
| Watertight Index | 0.568 | 0.300 | 0.470 | 0.190 |
| Improvement | | 47.2% | | 59.6% |
| Airtight Index | 0.404 | 0.373 | 0.352 | 0.346 |
| Improvement | | 7.7% | | 1.7% |
| | Number of closures: opened by the evacuees / initially closed | | | |
| Watertight Doors | 76/87 | 55/87 | 67/75 | 51/75 |
| Watertight Hatches | 20/22 | 19/22 | 19/22 | 19/22 |
| Watertight Scuttles | 15/23 | 4/23 | 16/23 | 4/23 |
| Airtight Doors | 37/46 | 32/46 | 42/46 | 31/46 |
| Airtight Hatches | 6/6 | 6/6 | 6/6 | 5/6 |
| Non-tight Doors | 21/91 | 11/91 | 73/85 | 67/85 |

Table 10. Objective-function, evacuation-time and ship-integrity comparisons for the damaged-ship scenario on the “USS STARK case.”

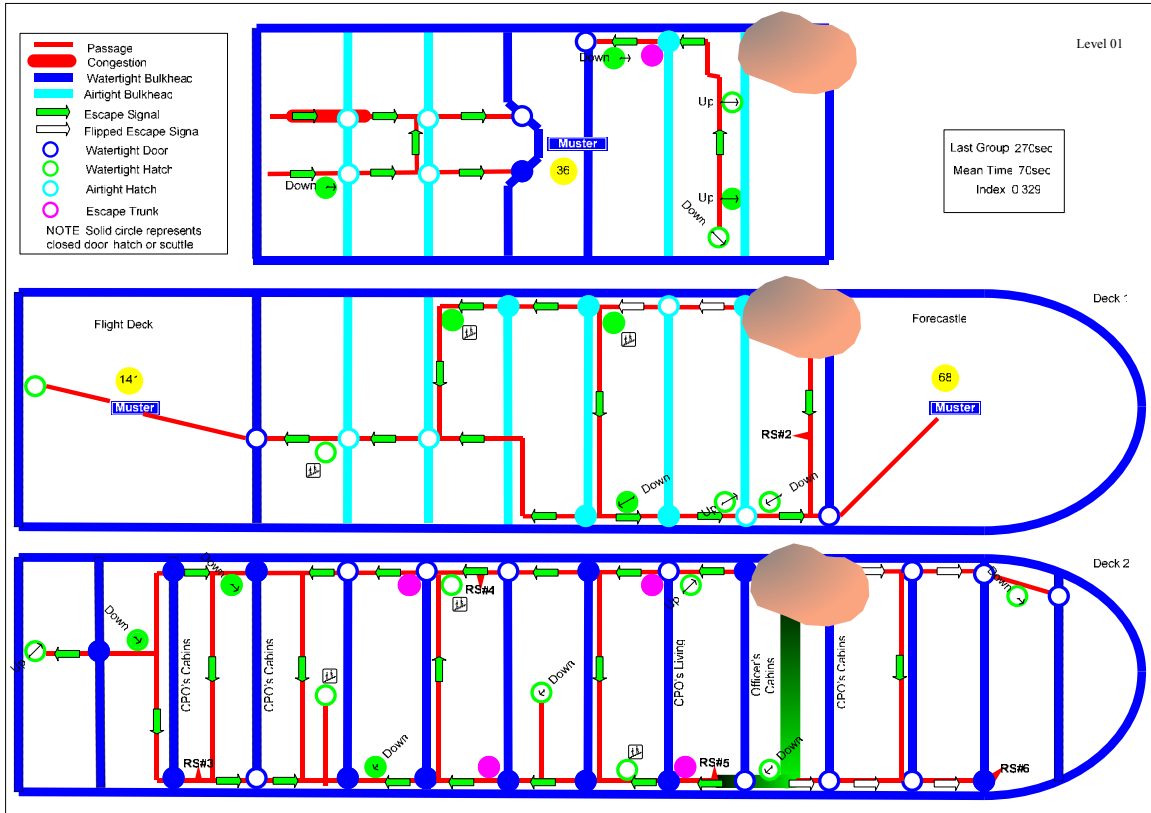

Figure 14. Comparing dynamic and static escape routes for the damaged-ship scenario: USS STARK case, watch condition. The shaded area represents the damaged zone and green passages are used by the repair parties.

Figure 14 depicts escape routes for a watch-condition scenario. The shaded area represents the damaged zone. Arcs inside this area are made impassable. A thick green line represents the passages used by repair parties to reach the damaged area. As in the previous section, white arrows represent escape signs that differ from those drawn from current static routes.

2. USS COLE Case

In this scenario, we assume that our frigate is moored (port side to pier) and a significant explosion occurs amidships, close to the waterline. This scenario represents a situation similar to that experienced by the USS COLE in 2000 (Wikipedia, 2005), although the COLE was not moored, but anchored in a supposedly “friendly” port at the time of the attack. Two important facts characterize this case:

- Most of the crew is resting on the lower decks.
- Only one ladder, on the flight deck, is available to reach the pier.

For obvious reasons, the only crew distribution analyzed in this scenario is Port, and the material condition is XRAY.

Under these assumptions, it is reasonable to expect that the majority of the crew would evacuate the ship by trying to reach the pier, and thus using the ladder situated on the flight deck. To model this scenario, we modify the capacity of the forecandle mustering station to 10% of the total crew (instead of the 65% assumed in other scenarios) and increase the capacity of the flight deck to 100%. This forces most of the crew to head towards the flight deck from their berthing rooms situated on Decks 3 and 2. We assume it is impossible to lower the boats, so we set the capacity of the boat deck to zero.

Repair parties will try to control flooding by pumping water through the escape trunk on the port side of the damaged engine room, as represented by the solid pink dot in Figure 15.

DER improves the evacuation process by 23% over the static plan, by reducing the mean evacuation time by 30 seconds and by keeping five more watertight doors closed. The time of the last evacuee also improves. DER take advantage of known usable passages to avoid congestion, despite the overuse of the flight-deck mustering station.

| | Port | |
|-----------------------------------|--|--------------|
| | Static | Dynamic |
| Objective Index | 0.471 | 0.349 |
| Improvement | | 22.8% |
| Mean Evacuation Time (sec) | 108 | 78 |
| Improvement | | 9.1% |
| Time of Last Group (sec) | 507 | 108 |
| Improvement | | -10.5% |
| Watertight Index | 0.052 | 0.027 |
| Improvement | | 47.2% |
| Airtight Index | 0.062 | 0.059 |
| Improvement | | 7.7% |
| | Number of closures: opened by the evacuees / initially closed | |
| Watertight Doors | 18/47 | 13/47 |
| Watertight Hatches | 0/1 | 0/1 |
| Watertight Scuttles | 5/23 | 0/23 |
| Airtight Doors | 0/0 | 0/0 |
| Airtight Hatches | 0/0 | 0/0 |
| Non-tight Doors | 65/85 | 62/85 |

Table 11. Objective function, evacuation time and ship integrity comparison for damaged-ship scenario, USS COLE case.

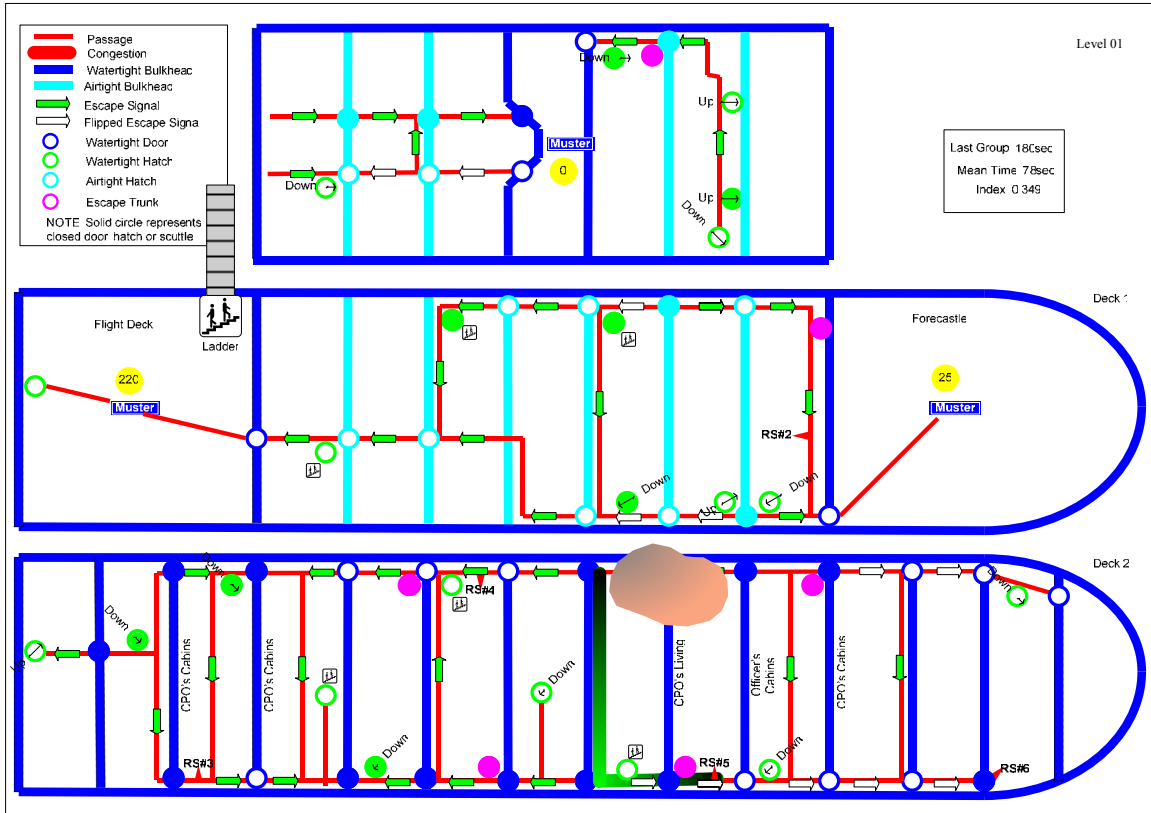

Figure 15. Comparing dynamic and static escape routes for damaged-ship scenario, USS COLE case, port condition.

D. DESIGN ASPECTS

Naval architects must demonstrate the effectiveness of a ship’s evacuation system during the early steps of the design process, when important changes do not have a serious budget impact. In theory, our DER model can be used to evaluate the effectiveness of various design alternatives. To demonstrate this possibility, we consider the following design modifications to the *ÁLVARO DE BAZÁN*:

- Add a watertight door to the forecastle, on the port side: The advantage of a second exit to the forecastle is obvious if one side is damaged, as occurred with the USS Stark. This modification would create a natural exit for the port passage.
- Increase the widths of passages, doors and stairs by 10%, in order to allow higher walking speeds when concurrent flow occurs. This modification is

always possible, in theory, but would require that a ship's dimensions be increased if compartments were to remain the same size.

We explore the new designs under the intact-ship scenarios. Results are presented in Tables 15-17 and Figure 6.

The addition of a new exit to the forecastle does not significantly improve mean evacuation time, mainly because few evacuees use that exit. This alternative would be more important in a damage case like the USS STARK attack, where a redundant exit could be used. In fact, if the exit to the forecastle (on the starboard side) were to become impassable, the *ÁLVARO DE BAZÁN* could not be completely evacuated with its current design.

Increasing all passage widths by 10% improves the mean evacuation time, especially for the watch scenario: The improved routes are 38% better than static escape routes and 13% better than the optimized routes without design changes. We caution the reader that these results require further experimentation and validation because they depend greatly on the walking-speed function used.

| | General Quarters | | | |
|-----------------------------|--|--------------|--------------|--------------|
| | Static | Dynamic | Forecastle | Width |
| Objective Index | 0.579 | 0.428 | 0.419 | 0.390 |
| Improvement | | 26.1% | 27.6% | 32.6% |
| Mean Evacuation Time | 64 | 57 | 57 | 47 |
| Improvement | | 10.9% | 10.9% | 25.6% |
| Time of Last Group | 143 | 106 | 116 | 93 |
| Improvement | | 25.9% | 18.9% | 35.0% |
| Watertight Index | 0.394 | 0.284 | 0.270 | 0.258 |
| Improvement | | 27.9% | 31.5% | 34.5% |
| Airtight Index | 0.392 | 0.317 | 0.315 | 0.228 |
| Improvement | | 19.1% | 19.6% | 41.8% |
| | Number of closures opened by evacuees/initially closed | | | |
| Watertight Doors | 79/87 | 59/87 | 59/89 | 59/89 |
| Watertight Hatches | 20/22 | 19/22 | 19/22 | 19/22 |
| Watertight Scuttles | 14/23 | 4/23 | 4/23 | 4/23 |
| Airtight Doors | 37/46 | 32/46 | 31/46 | 32/46 |
| Airtight Hatches | 5/6 | 6/6 | 6/6 | 6/6 |
| Non-tight Doors | 21/91 | 11/91 | 11/91 | 11/91 |

Table 12. Objective function, evacuation time and ship integrity comparison for new design under general quarters and no damage.

| | Watch | | | |
|-----------------------------|--|----------------|-------------------|--------------|
| | <i>Static</i> | <i>Dynamic</i> | <i>Forecastle</i> | <i>Width</i> |
| Objective Index | 0.455 | 0.339 | 0.331 | 0.266 |
| <i>Improvement</i> | | 25.5% | 27.2% | 41.5% |
| Mean Evacuation Time | 70 | 59 | 57 | 43 |
| <i>Improvement</i> | | 15.7% | 18.6% | 38.6% |
| Time of Last Group | 131 | 106 | 124 | 104 |
| <i>Improvement</i> | | 19.1% | 5.3% | 20.6% |
| Watertight Index | 0.44 | 0.178 | 0.16 | 0.132 |
| <i>Improvement</i> | | 59.5% | 63.6% | 70.0% |
| Airtight Index | 0.33 | 0.302 | 0.357 | 0.258 |
| <i>Improvement</i> | | 8.5% | -8.2% | 21.8% |
| | Number of closures opened by evacuees/initially closed | | | |
| Watertight Doors | 68/75 | 55/75 | 56/77 | 55/75 |
| Watertight Hatches | 19/22 | 19/22 | 19/22 | 19/22 |
| Watertight Scuttles | 17/23 | 4/23 | 4/23 | 4/23 |
| Airtight Doors | 42/46 | 31/46 | 33/46 | 32/46 |
| Airtight Hatches | 6/6 | 5/6 | 5/6 | 5/6 |
| Non-tight Doors | 73/85 | 68/85 | 68/85 | 68/85 |

Table 13. Objective function, evacuation time and ship integrity comparison for new design under watch and no damage.

| | Port | | | |
|-----------------------------|--|----------------|-------------------|--------------|
| | <i>Static</i> | <i>Dynamic</i> | <i>Forecastle</i> | <i>Width</i> |
| Objective Index | 0.326 | 0.262 | 0.252 | 0.241 |
| <i>Improvement</i> | | 19.6% | 22.7% | 26.1% |
| Mean Evacuation Time | 70 | 56 | 55 | 38 |
| <i>Improvement</i> | | 20.0% | 21.4% | 45.7% |
| Time of Last Group | 115 | 80 | 90 | 79 |
| <i>Improvement</i> | | 30.4% | 21.7% | 31.3% |
| Watertight Index | 0.04 | 0.022 | 0.005 | 0.005 |
| <i>Improvement</i> | | 45.0% | 87.5% | 87.5% |
| Airtight Index | 0.061 | 0.060 | 0.059 | 0.059 |
| <i>Improvement</i> | | 1.6% | 3.3% | 3.3% |
| | Number of closures opened by evacuees/initially closed | | | |
| Watertight Doors | 21/47 | 12/47 | 12/49 | 12/47 |
| Watertight Hatches | 0/1 | 0/1 | 0/1 | 0/1 |
| Watertight Scuttles | 6/23 | 0/23 | 0/23 | 1/23 |
| Airtight Doors | 0/0 | 0/0 | 0/0 | 0/0 |
| Airtight Hatches | 0/0 | 0/0 | 0/0 | 0/0 |
| Non-tight Doors | 65/85 | 61/85 | 63/85 | 63/85 |

Table 14. Objective function, evacuation time and ship integrity comparison for new design under port and no damage.

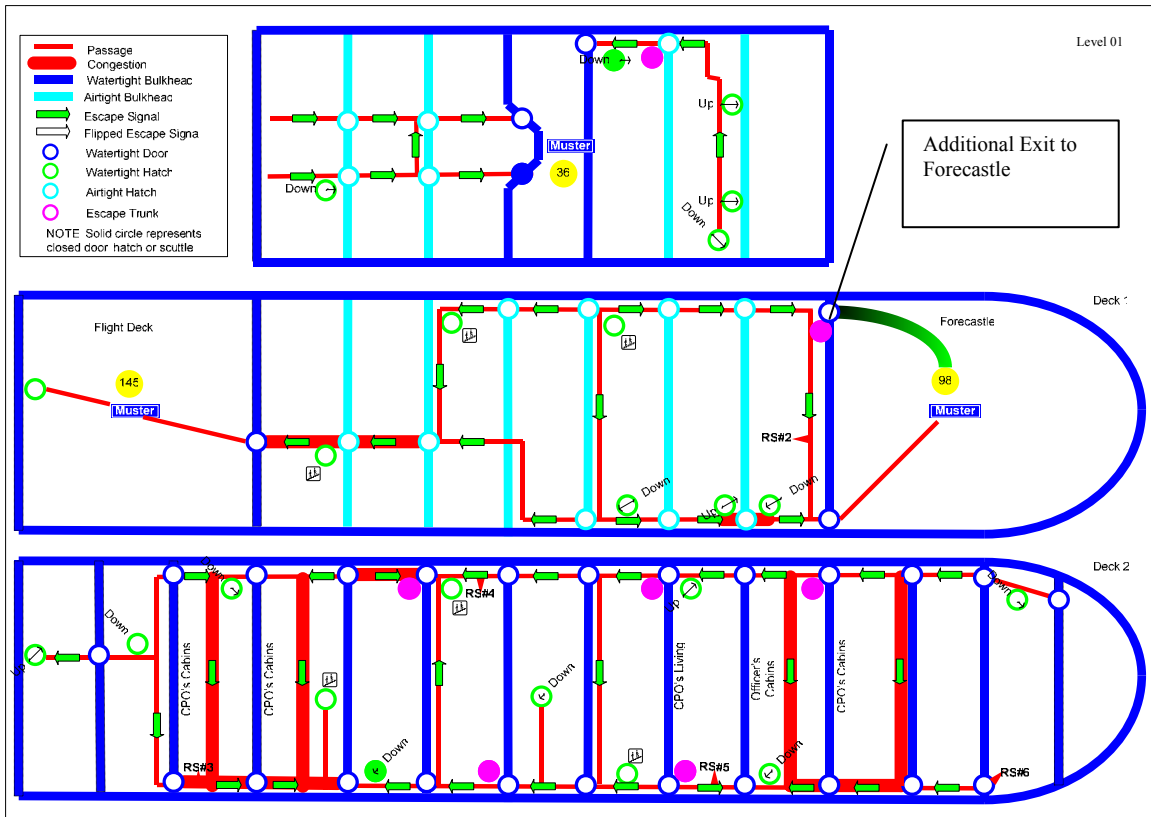

Figure 16. Comparing dynamic and static escape routes for new design: additional forecastle exit under port condition

E. MODEL DETAILS AND ALGORITHM PERFORMANCE

Table 15 summarizes the computational performance and results of our model that incorporates a network of 639 nodes and 1435 arcs.

| | | General Quarters | | Watch | | Port | |
|---|------------------|------------------|----------------|---------------|----------------|---------------|----------------|
| | | <i>Static</i> | <i>Dynamic</i> | <i>Static</i> | <i>Dynamic</i> | <i>Static</i> | <i>Dynamic</i> |
| Objective Index (Z^*) | | 0.5792 | 0.4283 | 0.4554 | 0.3385 | 0.3259 | 0.2615 |
| LP relaxation objective | | 0.5781 | 0.4224 | 0.4553 | 0.3387 | 0.3259 | 0.2567 |
| Lower Bound Index (Z^0) | | 0.2612 | 0.2195 | 0.2608 | 0.2137 | 0.2777 | 0.2212 |
| Gap ($Z^* - Z^0$) | | 0.318 | 0.2088 | 0.1946 | 0.1248 | 0.0482 | 0.0403 |
| Number of groups | | 40 | 40 | 90 | 90 | 54 | 54 |
| Number iterations | | 5 | 7 | 5 | 7 | 4 | 6 |
| Total time | | 82 | 127 | 1,788 | 7,647 | 59 | 83 |
| | | | | | | | |
| Constraints | <i>Initial</i> | 58,539 | 58,590 | 338,234 | 367,665 | 43,276 | 60,457 |
| | <i>Presolved</i> | 44,159 | 48,759 | 305,524 | 312,456 | 23,838 | 47,179 |
| Binary variables | <i>Initial</i> | 46,137 | 48,708 | 103,692 | 108,976 | 62,174 | 65,585 |
| | <i>Presolved</i> | 24,254 | 35,424 | 54,439 | 67,443 | 32,570 | 47,656 |
| Non-zero elements | <i>Initial</i> | 204,001 | 211,759 | 871,819 | 890,567 | 203,675 | 248,255 |
| | <i>Presolved</i> | 114,245 | 136,666 | 669,253 | 696,112 | 82,499 | 147,030 |

Table 15. Summary of computational results. The “initial” number of constraints, binary variables and non-zero elements are recorded in the last iteration of the solution heuristic. “Presolved” numbers are the “initial” values after the Xpress presolver has operated on and simplified the model.

All cases are solved after four to seven iterations, and require between 54 seconds (static port case) and 7,647 seconds (dynamic watch case). The latter case is much more difficult to solve than others. However, we note that its objective value is within 1.2% of

the final solution after the fourth iteration, and four iterations only require 2,637 seconds. Thus, additional research may show it possible to stop earlier with a solution of acceptable quality.

The gap between the best objective value found and the lower bound obtained after the first iteration (which assumes maximum walking speed and all closures to be open), is smaller for the port scenario than for the general-quarters scenario. This is attributable to the fact that fewer closures are closed in the port case: The ordered MCR is XRAY, which entails the greatest number of open closures. The smallest gap is about 18%, however, so near-optimality of the heuristic solution procedure cannot be claimed.

VI. CONCLUSIONS AND RECOMMENDATIONS

A. CONCLUSIONS

We have developed a network-based optimization model to plan the escape routes in a naval ship using dynamically configured escape signals. As part of a full “dynamic escape route system” (DER), these signals can guide crewmembers to escape routes that are modified depending on the contingency. For instance, if an enemy weapon is expected to hit a particular section of the ship, routes can be configured to avoid that section. The routes are also modified depending on the physical distribution of the crew, which can vary widely depending on the ship’s status (e.g., in port) and the passages used by repair parties.

The evacuation process is represented by a nonlinear network-flow optimization model (with side constraints). The model is driven not only by the goal of reducing average evacuation time (as is typically the case in evacuation models for buildings, mass-transit vehicles and passenger ships), but also by the importance of maintaining watertight and airtight integrity. We solve the model heuristically with good results, although bounds on solution quality are weak in practice. An important feature of our model is that we are able take in account the time variable without employing a time-phased network notably reducing the computational effort.

We use the *ÁLVARO DE BAZÁN*, a modern Spanish frigate, as the “test subject.” We demonstrate that a DER on that ship could (1) reduce mean evacuation time, and (2) improve the ship’s integrity by reducing the number of closures that must be opened to facilitate escape. Both improvements are key to reducing the risks that evacuees face and increasing the likelihood of a later safe rescue.

Specifically, DER can improve evacuation time up to 20% and improve the time of the last group of evacuees up to 30% compared to a system of static routes. The number of closures that must be opened is reduced by as much as 25%, also. The smallest improvements are achieved under a general-quarters scenario with no damage to the ship (for instance, only a 10.9% improvement in evacuation time). However, these small

improvements probably just indicate that the static escape-route plan, taken from the ship's technical drawings, has been designed for this scenario.

Unlike a static plan, DER can adapt to damage incurred in combat, or while harbored, as in the case of the USS COLE. Moreover, we demonstrate that the DER can be used to analyze the value that design changes can have with respect to evacuation effectiveness. For instance, we show that increasing in passage widths by only 10% on the ÁLVARO DE BAZÁN, could further reduce mean evacuation time between 25% and 45% depending on the scenario.

Escape trunks and vertical trunks, which connect lower-deck compartments with upper-decks passages, play an important role in the evacuation process and are the preferred escapes routes for the crewmembers located in engine rooms, and certain other compartments. Escape trunks are an attractive alternative to companionways because using them reduces a ship's integrity only minimally, and they can offer good fire and smoke protection to evacuees. We recommend the use of one or more escape trunks in all the manned compartments below the damage control deck (Deck 2).

Our DER model also identifies groups of crewmembers that are the last to escape (although this is not stated explicitly as model's objective). This could be useful for planning the appropriate distribution of emergency breathing devices.

Overall, we demonstrate that DER can contribute to reducing risks faced by sailors in the event of an evacuation. Furthermore, the optimization model could be a useful tool for the effective design of a naval ship. We recommend further study using fully vetted data and simulation exercises, on existing ships and ship prototypes, to validate the DER concept.

B. RECOMMENDATIONS FOR FURTHER STUDY

The accuracy of the evacuation time calculated by the DER model depends greatly on the estimated speed function used and the estimated times to open closures of various sorts. Most of the walking-speed functions described in the literature describe people moving in buildings, unconstrained spaces and mass-transit vehicles. The models cover a wide range of ages and fitness conditions for the walkers, but do not account for

the peculiarities of naval ships; for instance, slopes on stairs, differ notably between a ship and a civilian building, and escape trunks are not the same as fire-escape ladders or stairs. Experimentation and full trials onboard naval ships should be carried out to find the best possible estimates for speed functions and closure-opening times.

We have assumed that crewmembers move in indivisible groups, but some improvements might be possible by requiring groups to split. Experimentation on this topic would be interesting.

In our computational study, the opening of any individual closure of a given type has been assumed to degrade a ship's integrity equally. But, this ignores much detail about a ship's construction. For instance, a watertight door opening into a large compartment may be more important than a watertight door opening into a small compartment, because of a greater potential for flooding in the former case. More research will be required to model such effects more accurately. Additional research might also lead to a model in which at least some doors are re-closed by the last crewmember passing through them: In a real evacuation, some would be closed and some would remain open.

We have solved the DER model heuristically, and in some cases, our lower bounds are weak: In those cases we cannot guarantee that our solution is near optimal. Stronger bounds can be sought by, for example, by anticipating the minimum number of doors that need to be opened (instead of assuming, when calculating the bound, that all doors are already open).

The model, of course, can be enhanced in many other aspects. For example, we may contemplate stochasticity in parts of the evacuation process, including injuries to people. We have assumed that closures require fixed times to open, but deformations due to explosions, heat and flood may cause times to vary stochastically, and even make closures impossible to open.

We also encourage the investigation of a time-phased network for modeling purposes. Such a model might improve solution accuracy by reducing the number of approximations needed, in particular, in constraints (7).

THIS PAGE INTENTIONALLY LEFT BLANK

LIST OF REFERENCES

- Barrett, B., Ran, B. and Pillai, R. (2000). Developing a dynamic traffic management modeling framework for hurricane evacuation (Paper No. 00-1595). Washington DC: *Transportation Research Board 79th Annual Meeting*.
- Blake, J. S., Galea, R. E., Gwynne, and S. (2002). Examining the effect of exit separation on aircraft evacuation performance during 90-second certification trials using evacuation modelling techniques. *Aeronautical Journal*, 106(1055), 1.
- Boxall, P., Gwynne, S., Filippidis, L., Galea, E.R. and Cooney, D. (2005). Advanced evacuation simulation software and its use in warships. *Proceedings of the Human Factors in Ship Design, Safety and Operation*, London UK, Publisher The Royal Institute of Naval Architects, 23-24 February 2005, 49-56
- Boyd, C. (1996). Herald of Free Enterprise car ferry disaster. Retrieved December 21, 2004, from University of South Australia Web site: http://business2.unisa.edu.au/cobar/corpresp/case_studies/study3.htm
- Bowman, B. L., Fruin, J. J., and Zegeer, C. V. (1989). In FHWA/IP (Ed.), *Planning design and maintenance of pedestrian facilities*. United States: Performer: Goodell-Grivas, Inc., Southfield, MI. Sponsor: Federal Highway Administration, McLean, VA. Office of Implementation. Mar 1989. 276p. Report: FHWA/IP88/019.
- Campbell, B. (2003). Ejection summary. *Flying Safety*, 59(1/2), 54.
- Chalmet, L.G., Francis, R.L. and Saunders P.B., (1982). Network models for building evacuation. *Management Science*, 28(1), 86.
- Compartment Letters for Ships. Retrieved January 26, 2005 from Integrated Publishing Informative Center Web site: http://www.tpub.com/content/advancement/12018/ess/12018_258.htm
- Davis, J. and Cash, J. (2002). Emergency Egress: It can save your life. Retrieved February 14, 2005 from the Navy Safety Center Web site: www.safetycenter.navy.mil

- Department of Navy Information Security Program Regulation (2002).
SECNAVINST 5510.36 Responsibility for National Security Cases.
- Dijkstra, E.W. (1959). A note on two problems in connexion with graphs. *Numerische Mathematik*, 1, 269–271
- ELSA, Emergency Escape Breathing Device (2005). Retrieved from Tyco / Scott Web
www.scotthealthsafety.com
- Emergency Egress. Retrieved May 16, 2005 from the Naval Sea Systems Command Web
site: <http://www.dcfp.navy.mil/mc/presentations/Egress.htm>
- Final Report on the capsizing on 28 September 1994 in the Baltic Sea of the Ro-Ro
passenger vessel MV Estonia. The Joint Accident Investigation Commission of
Estonia, Finland and Sweden (1997). Retrieved December 11, 2004 from
www.onnettomuustutkinta.fi/estonia
- Fire protection handbook. AE Cote, JL Linville (1991) Quincy, Mass.: National Fire
Protection Association.
- First steps towards naval SOLAS. Technical news and information for the naval industry,
Naval Bulletin September, 2003 Issue 1, Lloyd's Register Marine Services.
Retrieved August 12, 2004 from the Lloyd's Register Web site:
http://www.lr.org/news/downloads/naval_bulletin_03-1.pdf
- Fletcher, R. and Sainz de la Maza, E. (1989). Nonlinear programming and nonsmooth
optimization by successive linear programming. *Mathematical Programming*,
43(3):235-256.
- Ford, L.R. and Fulkerson, D. R. (1958). Constructing maximal dynamic flows from static
flows. *Operations Research*, 6:419 - 433, 1958
- Francis, R. L. and Saunders, P. B. (1979). EVACNET: Prototype Network Optimization
Models for Building Evacuation (Rep. No. NBSIR 79-1593). Natl. Bur. Stand.,
(U.S.).

- Frantzich, H (1994). A model for performance-based design escape routes (Report 1011).
Lund University, Lund Institute of Technology, Department of Fire Safety Engineering.
- Fruin, J. J. (1971). Pedestrian planning and design. Metropolitan Association of Urban Designers and Environmental Planners inc. New York 1971.
- Galea, E.R. and Owen, M. (1994). Predicting the evacuation performance of mass Transport Vehicles. *IMarE Conference*, 106, 2, 239-247.
- Galea, E.R., Owen, M.P. and Lawrence, J. (1996), Computer modelling of human behaviour in aircraft fire accidents. *Toxicology* 115, 63-78.
- Galea, E.R., Blake, J, S., Gwynne, and S. (2003). The use of evacuation modelling techniques in the design of very large transport aircraft and blended wing body aircraft. *Aeronautical Journal* [H.W.Wilson - AST], 107, 207.
- Gwyne, S., Galea, E.R., Owen, M., Lawrence, P.J. and Filippidis, L. (1999). A Review of the Methodologies Used in Evacuation Modeling. *Fire and Materials*, 23, 383-388.
- Gwynne, S., Galea, E. R., Lawrence, P.J., Owen, M., and Filippidis, L. (1999). A Review of the methodologies used in the computer simulation of evacuation from the built environment, *Building and Environment*, 34, 741-749.
- Hinkle, J. and Glover, T. Glover, (2004). Reduced Manning in DDG 51 Class Warships: Challenges, opportunities and the way ahead for reduced manning on all United States Navy ships. Retrieved Januray 2, 2005 from <http://www.stormingmedia.us/61/6112/A611224.html>
- Interim guidelines for evacuation analyses for new and existing passenger ships (MSC/Circ 1033). International Maritime Organization (2002).
- Jarvis, J, J., Ratliff, and Donald, H. (1982). Some equivalent objectives for dynamic network flow problems. *Management Science*, 28(1), 106.

- Kuligowski, E. (2005). Review of 28 Egress Models. Retrieved June 24, 2005 from the National Institute of Standards and Technology Web site: <http://fire.nist.gov/bfrlpubs/fire05/PDF/f05008.pdf>
- Lazisky, R. (2005). CVX, Evolution of a revolution. Retrieved July 23, 2005 from the Navy League of the United States Web site: http://www.navyleague.org/seapower/evolution_of_a_revolution.htm
- López, A., and Pérez, F. (2001). Designer and master aids to improve the evacuation of passengers ships. Universidad Politécnica de Madrid, E.T.S.I. Navales, RandD Group on Aboard Human Factors.
- Løvås, G. G. (1995). On performance measures for evacuation systems. *European Journal of Operations Research*, 85(2), 352-367.
- Malone, David B. (2000). The Newsletter of the USS Buchanan (DDG-14) Association. *Newsletter Catalogue*. June 26, 2000. Vol. II., No. 2
- Microsoft Office Excel 2003 Small Business Edition. Microsoft Corporation (www.microsoft.com)
- Microsoft Office Visio 2003 Professional. Microsoft Corporation (www.microsoft.com)
- McComas (1998). Beyond the General Belgrano and Sheffield: Lessons in undersea and surface warfare from the Falkland Islands conflict. MIDN 4/C Swartz. *Naval Science* 2 (Research Paper). Retrieved May 16, 2005 from <http://www.hms-juno.co.uk/sheff/>
- Naval Sea Systems Command (2000). Damage Control Booklet Inspection, Maintenance and Repair of Watertight Closures. Revision 2.
- Practical Damage Control (1993). Naval Ship's Technical Manual (NSTM), chapter 079, vol. 2
- Navy to build ships to ABS class. Retrieved July 30, 2004 from the Marinelog Web site: <http://www.marinelog.com/DOCS/NEWSMMIV/MMIVJul30.html>
- National Fire Protection Association. Quincy, MA: Life Safety Code. NFPA 101, 2000, 1.

- Naval Postgraduate School Format. Dell, R. F. (2002). Operations Research Department, Naval Postgraduate School, Draft 22 October 2002.
- Okazaki, S. and Matsushita, S. (2004). A study of simulation model for pedestrian movement with evacuation and queing. Retrieved August 12, 2005 from www.anc-d.fukui-u.ac.jp/~sat/ECS93.pdf
- Pauls, J. (1988). Movement of people. SFPE Handbook of Fire Protection Engineering. NFPA Quincy MA, USA 1988.
- Pauls, J. (1984). The movement of people in buildings and design solutions for means of egress. *Fire Technology*, 20, 1, 27-47.
- Pauls, J. (2005). Elevators and stairs for comparisons and combinations. *Elevator World*, 53(1), 69-74.
- Predtetschenski V.M. and Milinski A.I. (1971). Personenströme in gebäuden - Berechnungsmethoden für die projektierung. Staatsverlag der Deutschen Demokratischen Republik. Berlin 1971.
- Predtetschenski V.M. and Milinski A.I. (1969). Planning for foot traffic flow in buildings. Translated from Russian, Amerind Publishing Co. Pvt. Ltd., New Delhi, India, 1978.
- Recommendations on evacuation analysis for new and existing passenger ships FP49/INF9, International Maritime Organization. Sub-Committee on Fire Protection 49th session, Agenda item 10, November 19th, 2004.
- Sattayhatewa, P. and Ran, B. (1999). Developing a dynamic traffic management model for nuclear power plant evacuation. Transportation Research Board Annual Meeting, July 29, 1999.
- Schroeder, J.E., Grant, M. and Tuttle, M. (1992). Modeling human behavior in aircraft evacuations. Proceedings of the 1992 Winter Simulation Conference.
- Second Report of the Operations Research Team on the Capacity of Footways (1958), Research Report No 95, London Transport Board, London, England

- SFPE Handbook of Fire Protection Engineering. National Fire Protection Association, Quincy, MA, 1995
- Sherali, H.D, Carter, T.B. and Hobeika, A.G. (1991). A location-allocation model and algorithm for evacuation planning under hurricane/flood conditions. *Transportation Research*, 25, 6, 439-452.
- Shestopal, V. O. and Grubits, S. J. (1994). Evacuation model for merging traffic flows in multi-room and multi-story buildings. In *Fire Safety Science - Proceedings of the 4th International Symposium*, 625-632.
- Taylor, S. (2004). Survival equipment for ship crews, safe evacuation from naval ships. *Naval Forces* , 25, 6, 54-59.
- The EXODUS Evacuation Page: Predicting the evacuation performance of mass transport vehicles using computer models. Retrieved November 10, 2004 from the University of Greenwich, The Fire Group Web site <http://www.greenwich.ac.uk/~lp03/TheFireGroup/galeamtx.html>
- The Homeland Security Presidential Directive/HSPD-8 National Preparedness. Retrieved December 10, 2003 from the White House Web site: www.whitehouse.gov/news/releases/2003/12/20031217-6.html
- Tjandra, S.A. (2003). Dynamic network optimization with application to the evacuation problem. (Doctoral Dissertation, Vom Fachbereich Mathematik der Universitat Kaiserlauten).
- Togawa, K. (1955). Study on fire escapes on the observation of multitude currents. Building Research Institute, Ministry of Construction. Tokyo 1955.
- United States Coast Guard: What is SOLAS?, With special emphasis on lifesaving and fire safety requirements (2002). Retrieved December 22, 2004 from www.uscg.mil/hq/g-m/mse4/solas.htm
- United States Coast Guard Evacuation Analysis Plan. Retrieved July 24, 2005 from <http://www.uscg.mil/hq/g-m/nmc/evacuation/downloads/execsum.pdf>

Watertight Closures, Inspection, Maintenance, and Repair. Damage Control Booklet
S9169-AW-DCB-010. Revision 2. Sea Systems Command, 2000.

Woodward, J. B. (1997). Titanic defended. *Marine Technology*, 34(2), 119-124.

XPress MP (Release 2004). Dash Optimization. www.dashoptimization.com

THIS PAGE INTENTIONALLY LEFT BLANK

APPENDIX A. MATERIAL CONDITION OF READINESS

The Material Condition of Readiness (MCR) is the degree of access and system closure in effect at any time on a naval ship. Naval ships have three basic MCRs: XRAY, YOKE and ZEBRA.

Closures such as doors, hatches and scuttles will remain open or closed depending on the MCR established, in anticipation of potential damage. Each MCR affords the ship with some level of protection, with XRAY providing the least protection and ZEBRA the most. On the other hand, the ZEBRA MCR provides the least degree of crew mobility on board, so it is only adopted during General Quarters. A more detail explanation follows;

- Condition XRAY: This provides the least watertight integrity and the greatest access throughout the ship. It is set during working hours when the ship is at home base and no attack is expected. Only closures marked with “X” and “Circle X” are closed;
- Condition YOKE: Provides a level of watertight integrity greater than XRAY and is set at port and sea during war time and in port during non-working times. Closures marked with “X”, “Y”, “Circle X” and “Circle Y” are closed;
- Condition ZEBRA: This MCR provides the greatest degree of watertight integrity and is established during following situations:
 - Immediately after ordering General Quarters.
 - Entering or leaving port during war time.
 - When controlling the spread of a fire or other damage when the crew is not at General Quarters
- Modified YOKE and ZEBRA: These are relaxations of the standard YOKE and ZEBRA, respectively, which can be ordered at discretion of the Commanding Officer;

- WILLIAM: Fittings (anything that may be opened or closed such as a door, vent or valve) are secured only as necessary to control damage or limit contamination from a chemical, biological, or radiological attack.

The MCR in each compartment is enforced by the crew responsible for the compartment but may be accomplished, in an emergency, by a repair party.

APPENDIX B. CREW LOCATION

Tables 16-22 in this appendix show the crew distribution for the Spanish frigate *ÁLVARO DE BAZÁN* by location (all decks and levels) and condition (General Quarters, Watch and Port); the data are derived from technical drawings. The tables also show the maximum expected occupancy of a compartment. The group's name is that as the compartment, following standard notation described in appendix C. Table 23 contains source nodes Cartesian coordinates.

| Group | Name | General Quarters | Watch | Port | Max |
|--------------|----------------------------|-------------------------|--------------|-------------|------------|
| 5-217-0-C | Sonar Dome | 1 | 0 | 0 | 1 |
| 4-193-1-C | Sonar Equipment Room | 6 | 3 | 0 | 6 |
| 4-171-2-E | Aux. Engines #1 | 1 | 0 | 0 | 1 |
| 4-155-0-E | Aux. Engines #2 | 1 | 1 | 0 | 1 |
| 4-141-0-E | Diesel Generators #1 | 2 | 1 | 0 | 2 |
| 4-123-0-E | Propulsion Engines Room #1 | 2 | 1 | 0 | 2 |
| 4-106-0-E | Aux Engines #3 | 2 | 1 | 0 | 2 |
| 4-89-0-E | Propulsion Engines Room #2 | 2 | 1 | 0 | 2 |
| 4-70-0-E | Diesel Generators #2 | 2 | 1 | 0 | 2 |
| 4-56-0-E | Aux Engines #4 | 1 | 0 | 0 | 1 |
| | TOTAL | 20 | 9 | 0 | 20 |

Table 16. Crew Location – Deck 4 and below

| Group | Name | General Quarters | Watch | Port | Max |
|--------------|-------------------|-------------------------|--------------|-------------|------------|
| 3-203-1-M | Ammo Magazine | 2 | 1 | 0 | 0 |
| 3-169-2-L2 | Rating's Berth #1 | 0 | 4 | 12 | 12 |
| 3-167-2-L2 | Rating's Berth #2 | 0 | 4 | 12 | 12 |
| 3-160-2-L2 | PO's Berth #2 | 0 | 2 | 6 | 6 |
| 3-160-1-L2 | PO's Berth #1 | 0 | 3 | 8 | 8 |
| 3-152-1-L2 | PO's Berth #4 | 0 | 3 | 8 | 8 |

| Group | Name | General Quarters | Watch | Port | Max |
|--------------|-------------------|-------------------------|--------------|-------------|------------|
| 3-150-2-L2 | PO's Berth #3 | 0 | 3 | 8 | 8 |
| 3-150-4-L2 | PO's Berth #5 | 0 | 2 | 6 | 6 |
| 3-60-2-L2 | Rating's Berth #5 | 0 | 4 | 12 | 12 |
| 3-59-2-L2 | Rating's Berth #4 | 0 | 3 | 9 | 9 |
| 3-59-1-L2 | Rating's Berth #3 | 0 | 3 | 9 | 9 |
| 3-54-4-L2 | Rating's Berth #7 | 0 | 3 | 9 | 9 |
| 3-53-3-L2 | Rating's Berth #6 | 0 | 3 | 9 | 9 |
| 3-47-2-L2 | Rating's Berth #8 | 0 | 4 | 12 | 12 |
| 3-47-1-L2 | Rating's Berth #9 | 0 | 3 | 9 | 9 |
| 3-40-3-L2 | PO's Berth #6 | 0 | 3 | 8 | 8 |
| 3-40-4-L2 | PO's Berth #9 | 0 | 2 | 6 | 6 |
| 3-40-2-L2 | PO's Berth #8 | 0 | 2 | 6 | 6 |
| 3-40-1-L2 | PO's Berth #7 | 0 | 2 | 6 | 6 |
| 3-32-1-L2 | PO's Berth #10 | 0 | 2 | 6 | 6 |
| 3-32-2-L2 | PO's Berth #11 | 0 | 2 | 6 | 6 |
| 3-3-0-E | Servo | 3 | 1 | 0 | 0 |
| | TOTAL | 5 | 59 | 167 | 167 |

Table 17. Crew Location – Deck 3

| Group | Name | General Quarters | Watch | Port | Max |
|--------------|---------------------|-------------------------|--------------|-------------|------------|
| 2-211-0-E | Windlass Room | 16 | 8 | 0 | 0 |
| 2-188-3-M | Mk41 Equipment Room | 1 | 0 | 0 | 0 |
| 2-168-1-L2 | CPO's Cabin #1 | 0 | 1 | 3 | 3 |
| 2-168-2-L2 | CPO's Cabin #2 | 0 | 1 | 3 | 3 |
| 2-168-4-L2 | CPO's Cabin #3 | 0 | 1 | 3 | 3 |
| 2-160-3-L2 | Officer's Cabin #1 | 0 | 1 | 2 | 2 |
| 2-160-1-L2 | Officer's Cabin #2 | 0 | 0 | 1 | 2 |
| 2-160-2-L2 | Officer's Cabin #3 | 0 | 1 | 2 | 2 |

| Group | Name | General Quarters | Watch | Port | Max |
|--------------|---------------------------|-------------------------|--------------|-------------|------------|
| 2-160-4-L2 | Officer's Cabin #4 | 0 | 0 | 2 | 2 |
| 2-151-3-L2 | Officer's Cabin #5 | 0 | 1 | 2 | 2 |
| 2-151-1-L2 | Officer's Cabin #6 | 0 | 1 | 2 | 2 |
| 2-151-2-L2 | Officer's Cabin #7 | 0 | 1 | 2 | 2 |
| 2-151-4-L2 | Officer's Cabin #8 | 0 | 0 | 2 | 2 |
| 2-143-1-L1 | CPO's Messroom | 0 | 3 | 0 | 26 |
| 2-141-2-L1 | CPO's Living | 0 | 6 | 0 | 17 |
| 2-131-1-C2 | Repair Station #5 | 16 | 8 | 0 | 0 |
| 2-130-2-L1 | Living and Emergency Room | 0 | 1 | 4 | 4 |
| 2-120-2-L3 | General Office | 0 | 2 | 0 | 0 |
| 2-109-1-L3 | Bakery | 2 | 0 | 0 | 0 |
| 2-106-2-L3 | Galley | 4 | 2 | 0 | 0 |
| 2-97-2-C2 | Repair Station #4 | 16 | 8 | 0 | 0 |
| 2-96-1-L2 | PO's Living | 0 | 9 | 0 | 17 |
| 2-88-1-L2 | Rating's Living | 0 | 7 | 0 | 20 |
| 2-69-0-L1 | PO's Messroom | 0 | 20 | 0 | 88 |
| 2-57-0-C1 | Platform Control | 6 | 3 | 0 | 0 |
| 2-55-1-C1 | Engineering Office | 0 | 2 | 0 | 0 |
| 2-54-2-L2 | CPO's Cabin #4 | 0 | 1 | 4 | 4 |
| 2-47-1-L2 | CPO's Cabin #5 | 0 | 1 | 2 | 2 |
| 2-47-0-C1 | Inertial Navigation Room | 3 | 1 | 0 | 0 |
| 2-47-2-L2 | CPO's Cabin #6 | 0 | 1 | 4 | 4 |
| 2-40-3-L2 | CPO's Cabin #7 | 0 | 1 | 4 | 4 |
| 2-40-1-L2 | CPO's Cabin #8 | 0 | 1 | 4 | 4 |
| 2-40-2-L2 | CPO's Cabin #9 | 0 | 1 | 4 | 4 |
| 2-40-4-L2 | CPO's Cabin #10 | 0 | 1 | 4 | 4 |
| 2-31-1-C2 | Repair Station #3 | 16 | 8 | 0 | 0 |
| 2-31-4-L2 | CPO's Cabin #12 | 0 | 1 | 4 | 4 |
| 2-31-2-L2 | CPO's Cabin #11 | 0 | 1 | 4 | 4 |

| Group | Name | General Quarters | Watch | Port | Max |
|--------------|---------------|-------------------------|--------------|-------------|------------|
| 2-21-2-L3 | Supply Office | 0 | 1 | 0 | 0 |
| 2-3-3-B | Nixie Room | 3 | 3 | 0 | 0 |
| 2-0-1-B | Atas Room | 2 | 1 | 0 | 0 |
| | TOTAL | 101 | 110 | 62 | 231 |

Table 18. Crew Location – Deck 2

| Group | Name | General Quarters | Watch | Port | Max |
|--------------|---------------------|-------------------------|--------------|-------------|------------|
| 1-161-1-C2 | Damage Control #2 | 10 | 0 | 0 | 0 |
| 1-144-0-C1 | CS Equip Room #2 | 5 | 2 | 0 | 0 |
| 1-130-1-L2 | CO Cabin | 0 | 0 | 0 | 1 |
| 1-127-2-L2 | Chiefs Cabin #1 | 0 | 1 | 1 | 1 |
| 1-123-2-L2 | Chiefs Cabin #2 | 0 | 0 | 1 | 1 |
| 1-122-1-L2 | XO Cabin | 0 | 0 | 1 | 1 |
| 1-117-4-L2 | Officer's Cabin #10 | 0 | 1 | 1 | 2 |
| 1-117-2-L2 | Officer's Cabin #9 | 0 | 0 | 2 | 2 |
| 1-108-1-L1 | Officer's Wardroom | 0 | 2 | 1 | 19 |
| 1-106-4-L1 | Officer's Messroom | 0 | 2 | 1 | 26 |
| 1-103-2-L3 | Officer's Pantry | 0 | 2 | 0 | 2 |
| 1-97-2-L2 | Officer's Cabin #11 | 0 | 1 | 2 | 2 |
| 1-92-1-L2 | Chief's Cabin #3 | 0 | 0 | 1 | 1 |
| 1-93-2-L2 | Officer's Cabin #12 | 0 | 1 | 1 | 2 |
| 1-88-2-L2 | Officer's Cabin #13 | 0 | 0 | 2 | 2 |
| 1-87-1-L4 | Treatment Room | 6 | 3 | 0 | 4 |
| 1-81-1-L4 | Hospital | 0 | 1 | 0 | 5 |
| 1-71-5-M | Torpedo Magazine #1 | 2 | 1 | 0 | 0 |
| 1-71-6-M | Torpedo Magazine #2 | 2 | 1 | 0 | 0 |
| 1-61-5-L4 | Gymnasium | 0 | 1 | 0 | 0 |
| 1-57-2-L3 | Hangar | 9 | 4 | 0 | 0 |

| Group | Name | General Quarters | Watch | Port | Max |
|--------------|--------------|-------------------------|--------------|-------------|------------|
| | TOTAL | 34 | 23 | 14 | 71 |

Table 19. Crew Location – Deck 1

| Group | Name | General Quarters | Watch | Port | Max |
|--------------|----------------------------|-------------------------|--------------|-------------|------------|
| 01-155-2-C1 | CIC | 16 | 8 | 0 | 0 |
| 01-155-1-C1 | CIC | 16 | 8 | 0 | 0 |
| 01-138-1-L | Meeting Room | 0 | 3 | 0 | 0 |
| 01-119-2-C1 | Main Communications Center | 8 | 4 | 0 | 0 |
| 01-68-1-C1 | Control Stm | 12 | 5 | 0 | 0 |
| 01-54-2-C | Sec Radio Center | 2 | 1 | 0 | 0 |
| 01-48-2-M | Meroka Equip Room | 3 | 2 | 0 | 0 |
| 01-46-1-C1 | Control Flight | 2 | 1 | 0 | 0 |
| | TOTAL | 59 | 32 | 0 | 0 |

Table 20. Crew Location – Deck 01

| Node | Name | General Quarters | Watch | Port | Max |
|-------------|-------------------|-------------------------|--------------|-------------|------------|
| 02-158-1-C1 | Navigation Bridge | 10 | 4 | 0 | 0 |
| 02-158-2-C1 | Navigation Bridge | 10 | 4 | 0 | 0 |
| 02-149-6-L3 | CO Pantry | 0 | 1 | 0 | 0 |
| 02-142-1-L2 | CO Cabin | 0 | 0 | 1 | 1 |
| 02-142-2-L2 | FO Cabin | 0 | 0 | 1 | 6 |
| | TOTAL | 20 | 9 | 2 | 7 |

Table 21. Crew Location – Deck 02

| Group | Name | GQ | Watch | Port | Max |
|--------------|--------------|-----------|--------------|-------------|------------|
| 03-158-0-C | Fly Bridge | 6 | 3 | 0 | 6 |
| | TOTAL | 6 | 3 | 0 | 6 |

Table 22. Crew Location – Deck 03

| Group | Name | X (m) | Y (m) | Z (m) |
|--------------|----------------------------|------------------|------------------|------------------|
| 5-217-0-C | Sonar Dome | 130.20 | 0.00 | 0.00 |
| 4-193-1-C | Sonar Equipment Room | 115.95 | 1.01 | 2.64 |
| 4-171-2-E | Aux. Engines #1 | 102.60 | -0.79 | 2.28 |
| 4-155-0-E | Aux. Engines #2 | 93.18 | 0.00 | 2.03 |
| 4-141-0-E | Diesel Generators #1 | 84.60 | 0.00 | 1.80 |
| 4-123-0-E | Propulsion Engines Room #1 | 73.98 | 0.00 | 1.51 |
| 4-106-0-E | Aux Engines #3 | 63.60 | 0.00 | 1.31 |
| 4-89-0-E | Propulsion Engines Room #2 | 53.36 | 0.00 | 1.31 |
| 4-70-0-E | Diesel Generators #2 | 42.13 | 0.00 | 1.31 |
| 4-56-0-E | Aux Engines #4 | 33.69 | 0 | 1.31 |
| 3-203-1-M | Ammo Magazine | 122.08 | 0.52 | 5.81 |
| 3-169-2-L2 | Rating's Berth #1 | 101.10 | -4.42 | 5.24 |
| 3-167-2-L2 | Rating's Berth #2 | 99.90 | -0.33 | 5.21 |
| 3-160-2-L2 | PO's Berth #2 | 96.00 | -4.78 | 5.10 |
| 3-160-1-L2 | PO's Berth #1 | 95.91 | 4.81 | 5.10 |
| 3-152-1-L2 | PO's Berth #4 | 91.31 | 2.46 | 4.98 |
| 3-150-2-L2 | PO's Berth #3 | 90.30 | -2.26 | 4.95 |
| 3-150-4-L2 | PO's Berth #5 | 90.30 | -6.23 | 4.95 |
| 3-60-2-L2 | Rating's Berth #5 | 36.00 | -5.68 | 4.31 |
| 3-59-2-L2 | Rating's Berth #4 | 35.13 | -1.82 | 4.31 |
| 3-59-1-L2 | Rating's Berth #3 | 35.11 | 0.79 | 4.31 |
| 3-54-4-L2 | Rating's Berth #7 | 32.58 | -5.89 | 4.31 |
| 3-53-3-L2 | Rating's Berth #6 | 32.06 | 5.68 | 4.31 |
| 3-47-2-L2 | Rating's Berth #8 | 28.50 | -5.48 | 4.31 |
| 3-47-1-L2 | Rating's Berth #9 | 28.18 | 5.58 | 4.31 |
| 3-40-3-L2 | PO's Berth #6 | 24.22 | 5.49 | 4.31 |
| 3-40-4-L2 | PO's Berth #9 | 24.20 | -4.66 | 4.31 |
| 3-40-2-L2 | PO's Berth #8 | 24.20 | -1.56 | 4.31 |

| Group | Name | X (m) | Y (m) | Z (m) |
|--------------|---------------------------|------------------|------------------|------------------|
| 3-40-1-L2 | PO's Berth #7 | 23.99 | 1.56 | 4.31 |
| 3-32-1-L2 | PO's Berth #10 | 19.11 | 5.01 | 4.31 |
| 3-32-2-L2 | PO's Berth #11 | 18.35 | -5.11 | 4.31 |
| 3-3-0-E | Servo | 1.78 | 0.00 | 4.31 |
| 2-211-0-E | Windlass Room | 126.83 | 0.00 | 7.722 |
| 2-188-3-M | Mk41 Equip Room | 112.64 | 1.26 | 7.339 |
| 2-168-1-L2 | CPO's Cabin #1 | 100.65 | 3.08 | 7.015 |
| 2-168-2-L2 | CPO's Cabin #2 | 100.65 | -0.10 | 7.015 |
| 2-168-4-L2 | CPO's Cabin #3 | 100.65 | -3.30 | 7.015 |
| 2-160-3-L2 | Officer's Cabin #1 | 96.05 | 4.55 | 6.891 |
| 2-160-1-L2 | Officer's Cabin #2 | 96.05 | 1.61 | 6.891 |
| 2-160-2-L2 | Officer's Cabin #3 | 95.94 | -1.19 | 6.888 |
| 2-160-4-L2 | Officer's Cabin #4 | 95.94 | -3.77 | 6.888 |
| 2-151-3-L2 | Officer's Cabin #5 | 90.54 | 3.31 | 6.742 |
| 2-151-1-L2 | Officer's Cabin #6 | 90.50 | 0.53 | 6.741 |
| 2-151-2-L2 | Officer's Cabin #7 | 90.46 | -2.32 | 6.740 |
| 2-151-4-L2 | Officer's Cabin #8 | 90.35 | -5.17 | 6.737 |
| 2-143-1-L1 | CPO's Messroom | 85.80 | 2.46 | 6.614 |
| 2-141-2-L1 | CPO's Living | 84.43 | -4.30 | 6.577 |
| 2-131-1-C2 | Repair Station #5 | 78.32 | 5.20 | 6.412 |
| 2-130-2-L1 | Living and Emergency Room | 78.00 | -3.90 | 6.403 |
| 2-120-2-L3 | General Office | 72.15 | -4.42 | 6.245 |
| 2-109-1-L3 | Bakery | 65.40 | 2.40 | 6.095 |
| 2-106-2-L3 | Galley | 63.55 | -3.81 | 6.095 |
| 2-97-2-C2 | Repair Station #4 | 57.99 | -5.23 | 6.095 |
| 2-96-1-L2 | PO's Living | 57.44 | 3.79 | 6.095 |
| 2-88-1-L2 | Rating's Living | 52.98 | 4.14 | 6.095 |
| 2-69-0-L1 | PO's Messroom | 41.62 | 0.00 | 6.095 |
| 2-57-0-C1 | Platform Control | 34.20 | 0.00 | 6.095 |

| Group | Name | X (m) | Y (m) | Z (m) |
|--------------|--------------------------|------------------|------------------|------------------|
| 2-55-1-C1 | Engineering Office | 33.16 | 5.46 | 6.095 |
| 2-54-2-L2 | CPO's Cabin #4 | 32.34 | -5.27 | 6.095 |
| 2-47-1-L2 | CPO's Cabin #5 | 28.04 | 4.86 | 6.095 |
| 2-47-0-C1 | Inertial Navigation Room | 28.00 | -0.04 | 6.095 |
| 2-47-2-L2 | CPO's Cabin #6 | 28.00 | -4.84 | 6.095 |
| 2-40-3-L2 | CPO's Cabin #7 | 24.23 | 4.93 | 6.095 |
| 2-40-1-L2 | CPO's Cabin #8 | 24.23 | 1.74 | 6.095 |
| 2-40-2-L2 | CPO's Cabin #9 | 24.17 | -1.50 | 6.095 |
| 2-40-4-L2 | CPO's Cabin #10 | 24.17 | -4.63 | 6.095 |
| 2-31-1-C2 | Repair Station #3 | 18.57 | 3.35 | 6.095 |
| 2-31-4-L2 | CPO's Cabin #12 | 18.52 | -3.78 | 6.095 |
| 2-31-2-L2 | CPO's Cabin #11 | 18.51 | -0.64 | 6.095 |
| 2-21-2-L3 | Supply Office | 12.59 | -6.09 | 6.095 |
| 2-3-3-B | Nixie Room | 1.77 | 6.02 | 6.095 |
| 2-0-1-B | Atas Room | -0.02 | 3.38 | 6.095 |
| 1-161-1-C2 | Damage Control #2 | 96.60 | 1.04 | 10.62 |
| 1-144-0-C1 | CS Equip Room #2 | 86.11 | 0.00 | 10.34 |
| 1-130-1-L2 | CO Cabin | 78.00 | 4.92 | 10.12 |
| 1-127-2-L2 | Chiefs Cabin #1 | 76.09 | -5.79 | 10.07 |
| 1-123-2-L2 | Chiefs Cabin #2 | 73.58 | -5.79 | 10.00 |
| 1-122-1-L2 | XO Cabin | 73.20 | 4.63 | 9.99 |
| 1-117-4-L2 | Officer's Cabin #10 | 70.38 | -6.08 | 9.91 |
| 1-117-2-L2 | Officer's Cabin #9 | 70.37 | -2.96 | 9.91 |
| 1-108-1-L1 | Officer's Wardroom | 64.94 | 2.17 | 9.81 |
| 1-106-4-L1 | Officer's Messroom | 63.38 | -4.78 | 9.81 |
| 1-103-2-L3 | Officer's Pantry | 61.80 | -0.31 | 9.81 |
| 1-97-2-L2 | Officer's Cabin #11 | 58.53 | -5.49 | 9.81 |
| 1-92-1-L2 | Chief's Cabin #3 | 55.67 | 5.00 | 9.81 |
| 1-93-2-L2 | Officer's Cabin #12 | 55.65 | -5.46 | 9.81 |

| Group | Name | X (m) | Y (m) | Z (m) |
|--------------|---------------------|------------------|------------------|------------------|
| 1-88-2-L2 | Officer's Cabin #13 | 52.76 | -5.46 | 9.81 |
| 1-87-1-L4 | Treatment Room | 52.37 | 5.43 | 9.81 |
| 1-81-1-L4 | Hospital | 48.59 | 5.45 | 9.81 |
| 1-71-5-M | Torpedo Magazine #1 | 42.77 | 6.01 | 9.81 |
| 1-71-6-M | Torpedo Magazine #2 | 42.30 | -6.18 | 9.81 |
| 1-61-5-L4 | Gymnasium | 36.45 | 6.43 | 9.81 |
| 1-57-2-L3 | Hangar | 34.10 | -1.30 | 9.81 |
| 01-155-2-C1 | CIC | 92.91 | -4.41 | 13.32 |
| 01-155-1-C1 | CIC | 92.91 | 4.42 | 13.32 |
| 01-138-1-L | Meeting Room | 82.80 | 5.98 | 13.04 |
| 01-119-2-C1 | Main Comm Center | 71.40 | -4.04 | 12.73 |
| 01-68-1-C1 | Control Stm | 41.10 | 5.76 | 12.61 |
| 01-54-2-C | Sec Radio Center | 32.68 | -7.49 | 12.61 |
| 01-48-2-M | Meroka Equip Room | 28.70 | -6.54 | 12.61 |
| 01-46-1-C1 | Control Flight | 27.90 | 2.60 | 12.61 |
| 02-158-1-C1 | Navigation Bridge | 94.99 | 3.38 | 16.18 |
| 02-158-2-C1 | Navigation Bridge | 94.99 | -3.38 | 16.18 |
| 02-149-6-L3 | CO Pantry | 89.23 | -1.98 | 16.02 |
| 02-142-1-L2 | CO Cabin | 85.49 | 3.22 | 15.92 |
| 02-142-2-L2 | FO Cabin | 85.33 | -1.55 | 15.92 |
| 03-158-0-C | Fly Bridge | 94.8 | 0 | 19.065 |

Table 23. Source-node Cartesian coordinates

THIS PAGE INTENTIONALLY LEFT BLANK

APPENDIX C. COMPARTMENT DESIGNATION NUMBERING SYSTEM

In 1949, the Compartment Designation Numbering System (CDNS) (Compartment Letters for Ships, 2005) was established by the U.S. Navy. Every compartment, hatch, door or bulkhead on board, except in minor spaces, is uniquely identified by a set of letters and numbers, providing information on the compartment's location and function. This symbol is marked on a label and secured to the compartment, hatch, door or bulkhead.

We use a similar convention to label the nodes in our network. Those who are familiar with the CDNS can easily identify a node and locate its position onboard. This set of letters and numbers consists of a deck number, a station number (the ship's length is divided into roughly equally spaced "stations," each one corresponding to a structural member such as a stiffener or frame member), a relative position of the compartment respect to the centerline, and a letter that represents the usage of the compartment. For example, the label in Figure 17 corresponds to a compartment on the third deck, forward the ship, station 75, it is the second compartment outboard of the centerline to port side and it is used for ammunition storage.

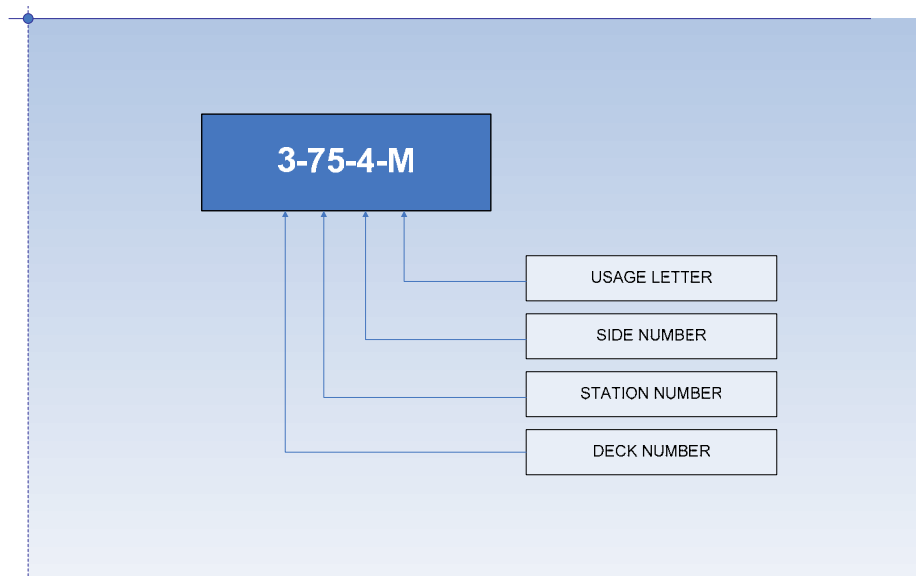

Figure 17. Example of node label following CDNS standard

A. DECK NUMBERS

The deck number indicates the vertical position of the compartment within the ship. The main deck, that is, the first continuous watertight deck that runs from the bow to the stern, receives the number 1. Decks below the main deck are the second, third, fourth decks, etc. and are numbered as 2, 3, 4 and so forth, respectively. Decks above the main deck are referred to as “levels” and numbered 01, 02, 03, i.e., a zero precedes the deck number. Numbers increase from the main deck towards the keel and upwards.

The frigate under study (see Figure 18) has three decks below the main deck and eight levels above the main deck, but crew is not expected to be above Level 04.

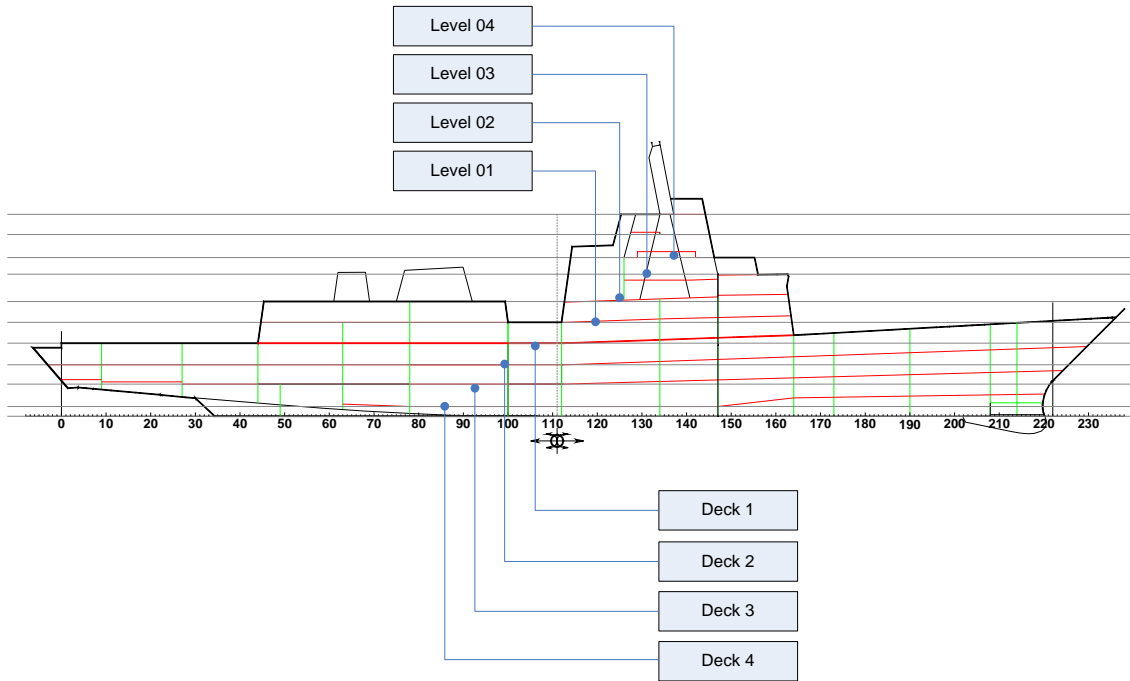

Figure 18. Deck numbers.

When a compartment such as an engine room extends through more than one deck, it receives the lowest relevant deck number.

B. FRAME NUMBER

Frame number (see Figure 19.) indicates the relative position from the AP, that is, the rudder stock centerline located at the station 0. When identifying a compartment, the frame number corresponds to the aftermost bulkhead of the compartment.

Note that a different convention prevails in the U.S. Navy: station 0 is located at the FP and the frame number indicates the foremost bulkhead of the compartment.

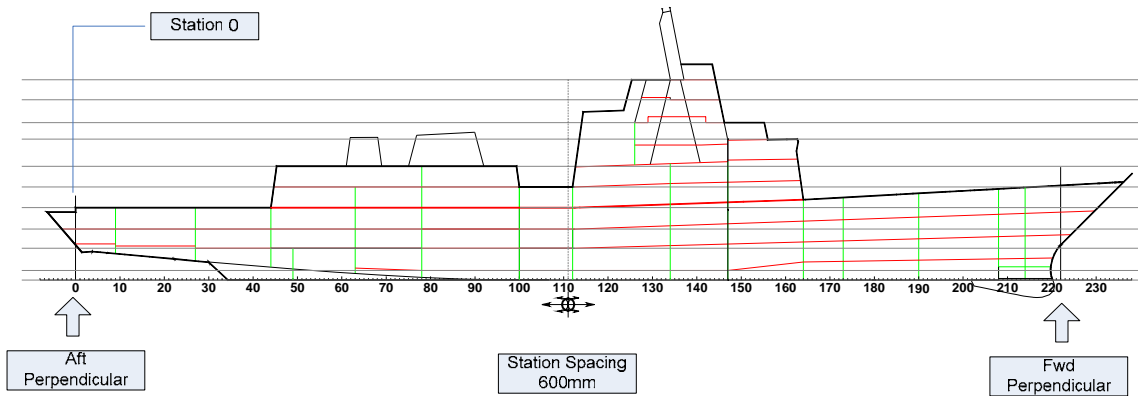

Figure 19. Station number

C. SIDE NUMBER

The side number (see Figure 20) indicates the relative position of the compartment to the ship centerline. Compartments located on the centerline of the ship are numbered as 0. Compartments on the starboard side have odd numbers and compartments on port side have even numbers. When there is more than one compartment on the same deck and frame, they take consecutive numbers.

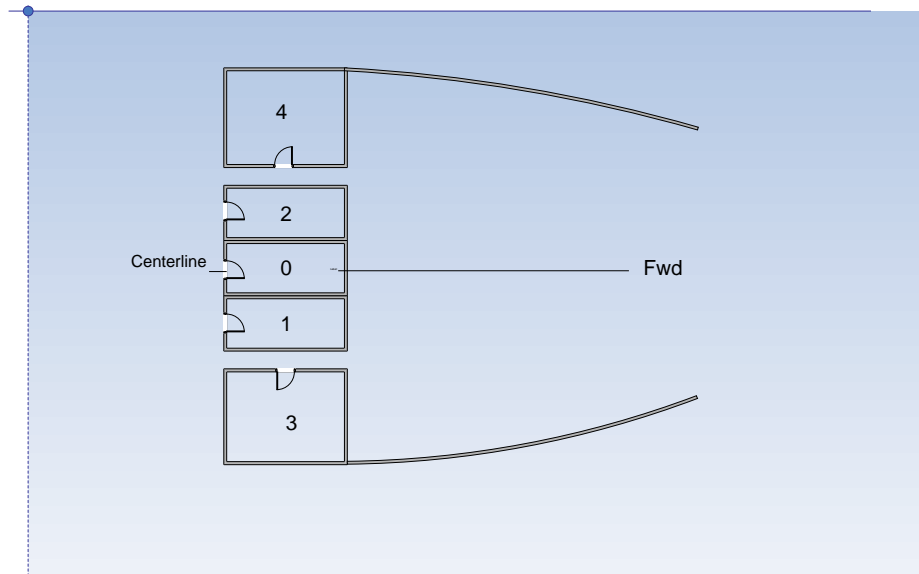

Figure 20. Side number.

D. USAGE LETTER

The usage letter indicates the primary use of the compartment. For instance, “L” stands for living spaces (berthing and messing spaces, staterooms, washrooms and sick bay) and “G” stands for gasoline stowage compartments. For completeness, we list the usage letters here and their meanings:

- A: Dry stowage storerooms, issue rooms, refrigerated spaces;
- B: Guns spaces;
- C: Ship control and fire control operating spaces, plotting rooms, CIC, radio, radar, sonar operating spaces, pilothouse;
- E: Engineering spaces, main propulsion spaces; pump, generator, and windlass rooms;
- F: Oil stowage fuel oil, diesel oil, and lubricating oil tanks;
- G: Gasoline stowage, gasoline tank compartments, cofferdams, trunks, and pump rooms;
- J: JP-5 tanks, aircraft fuel stowage;

- K: Chemicals and dangerous materials, stowage of chemicals and semi-safe and dangerous materials, except oil and gasoline tanks;
- L: Living spaces, berthing and messing spaces, medical and dental areas, and passageways;
- M: Ammunition stowage and handling.
- Q: Spaces not otherwise covered, e.g., ship's offices, laundry rooms, galleys, pantries, and wiring trunks;
- T: Vertical access trunks;
- V: Void cofferdam compartments, other than gasoline and void wing compartments;
- W: Water stowage compartments, including bilge, sump, and peak tanks; and,
- AA: Spaces used to carry cargo.

Some letters are unnecessary to our work since we do not expect to find crewmembers in compartments such as void spaces (letter V) or fresh-water stowage spaces (letter W). But we are interested in differentiating spaces like damage-control repair stations or berthing spaces that would normally fall into the same category.

The reason for this division into subcategories is that, based on the type of compartment, we are able to estimate the difficulty that occupants may have to find the exit: we assume that it will be easier to find the compartment exit from a relatively sparsely outfitted living space, than it will be in an engine room packed with equipment. This effect is captured by the “permeability factor” which we embed in our model as part of arc lengths.

We expand the standard classification scheme by adding some subcategories:

- B: Gunnery spaces;
- C1: Ship control spaces;
- C2: Damage control repair stations;
- E: Engineering spaces;

- L1: Living spaces;
- L2: Berthing spaces;
- L3: Working spaces;
- L4: Medical spaces;
- M: Ammunition magazine;
- T: Passage or corridor;
- T1: Access trunk;
- T2: Vertical trunk; and,
- T3: Escape trunk.

APPENDIX D. CLOSURES

Table 24 lists a variety of closures typical on naval ships.

| Symbol | Description | Symbol | Description |
|--------|-------------------------------------|--------|---------------------------------|
| AD | Armored Door | HMHC | Hinged Manhole Cover |
| AH | Armored Hatch | LP | Low Profile |
| AHC | Ammunition Hoist Cover | MHC | Manhole Cover |
| AHD | Ammunition Hoist Door | MIG | Metal Inert Gas |
| AP | Air Port | NTD | Non-tight Door |
| AQAES | Armored Quick-Acting Escape Scuttle | PS | Passing Scuttle |
| AS | Armored Scuttle | QA | Quick-Acting |
| ATC | Air Test Cap | QAAD | Quick-Acting Armored Door |
| ATD | Airtight Door | QAAH | Quick-Acting Armored Hatch |
| AT/FZ | Airtight/Firezone Door | QAAS | Quick-Acting Armored Scuttle |
| ATS | Airtight Scuttle | QAATD | Quick-Acting Airtight Door |
| AWTD | Armored Watertight Door | QAES | Quick-Acting Escape Scuttle |
| AWTH | Armored Watertight Hatch | QAWTD | Quick-Acting Watertight Door |
| BA | Ballistic Armor | QAWTH | Quick-Acting Watertight Hatch |
| BERP | Bolted Equipment Removal Plate | QAWTS | Quick-Acting Watertight Scuttle |
| BP | Baffle Ports | RLP | Ramped Low Profile |
| CRES | Corrosion Resistant Steel | SMAW | Shielded Metal Arc Welding |
| FTD | Firetight Door | TIG | Tungsten Inert Gas |
| FT/FZ | Fumetight Firezone (Door) | WTC | Watertight Closure |
| GPR | Glass-Reinforced Plastic | WTD | Watertight Door |
| GTAW | Gas Tungsten Arc Welding | WTH | Watertight Hatch |

Table 24. Extensive list of closures on naval ships

Figures 21-26 show closures that have been explicitly modeled in our research by establishing (a) time to open and (b) effect on watertight or airtight integrity, if opened. A short description of these closures follows. For more details, see the damage control booklet *Watertight Closures* (2000).

- Quick-acting watertight doors. These doors are located in high traffic areas, such as in the superstructure where they give access to the weather decks, main passageways, and manned spaces (Combat Information Center, Radio Central, Machinery Control Central, or Damage Control Central). Ship Integrity Index Weight $\gamma_n=0.75 \times 0.50$.

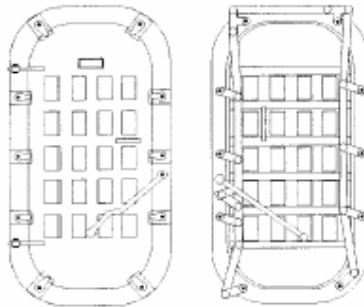

Figure 21. Quick- Acting WTD

- Quick-acting airtight doors. These doors are located above the V-lines and are used to access fan rooms, storerooms, and spaces where interior bulkheads are required to be airtight. These doors prevent the spread of fire, toxic vapors, and smoke. Ship Integrity Index Weight $\gamma_n=0.25 \times 0.50$.

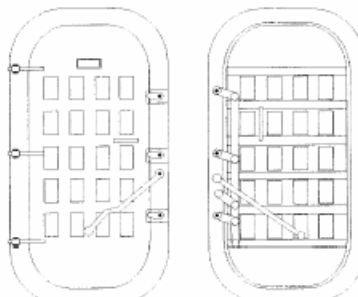

Figure 22. Quick Acting ATD

- Raised watertight hatches. These hatches are installed in areas where rapid access is not required. They do not have escape scuttles, and are usually used for unloading or offloading stores and access for heavy equipment engine rooms and stores. Ship Integrity Index Weight $\gamma_n=0.75 \times 0.40$.

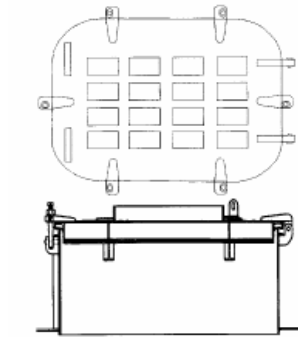

Figure 23. Raised WTH

- Raised watertight hatches with scuttles. These hatches are in places where rapid access or egress is required. They have escape scuttles to provide rapid access or egress, and are usually located above berthing compartments, manned and unmanned machinery spaces, and all deck levels. Ship Integrity Index Weight $\gamma_n=0.75 \times 0.10$.

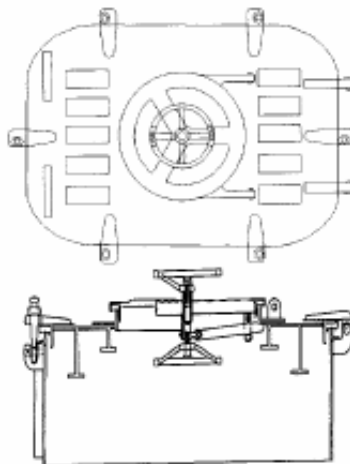

Figure 24. Raised WTH with Scuttle

- Raised watertight scuttles. These scuttles are installed in interior and exterior areas, and provide an alternate access to manned or unmanned spaces, machinery spaces, or storerooms. Ship Integrity Index Weight $\gamma_n=0.25 \times 0.10$.

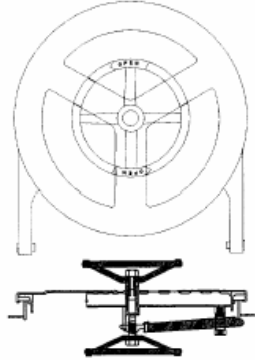

Figure 25. Raised WTS

- Flush watertight scuttles. These scuttles are installed in areas such as flight decks, cargo decks, hangar decks, passageways, or areas of relatively high traffic where a flush deck condition is required. Ship Integrity Index Weight $\gamma_n=0.75 \times 0.10$.

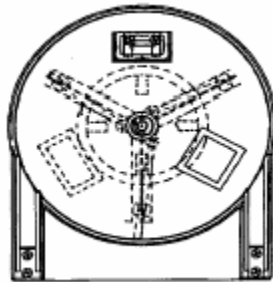

Figure 26. Flush WTS

Table 25 lists closure locations on ÁLVARO DE BAZÁN frigate, along with the closure type and mark.

| Node | Type | Fitting Mark | Description | X (m) | Y (m) | Z (m) |
|-------------|-------------|---------------------|----------------------|------------------|------------------|------------------|
| 5-215-0-T2 | T2 | X | Scuttle | 128.73 | 0.00 | 0.00 |
| 4-209-0-T2 | T2 | X | Scuttle | 125.27 | 0.00 | 2.90 |
| 4-198-2-WTD | WTD | Y | Compartment Access | 118.84 | -0.52 | 2.72 |
| 4-172-1-WTD | WTD | Y | Compartment Access | 103.09 | 2.87 | 2.30 |
| 4-170-1-WTD | WTD | Y | Compartment Access | 102.00 | 3.34 | 2.27 |
| 4-159-2-WTD | WTD | X | Escape Trunk Access | 95.37 | -4.16 | 2.09 |
| 4-155-1-WTD | WTD | Y | Compartment Access | 93.00 | 4.31 | 2.02 |
| 4-135-1-WTD | WTD | X | Escape Trunk Access | 81.03 | 5.72 | 1.70 |
| 4-133-2-WTD | WTD | X | Escape Trunk Access | 79.83 | -5.72 | 1.67 |
| 4-99-1-WTD | WTD | X | Escape Trunk Access | 59.40 | 5.72 | 1.31 |
| 4-76-2-WTD | WTD | X | Escape Trunk Access | 45.60 | -6.24 | 1.31 |
| 3-209-0-WTS | WTS | X | Scuttle | 125.27 | 0.00 | 5.90 |
| 3-203-2-WTD | WTD | Y | Ammo Magazine Access | 121.60 | -0.52 | 5.80 |
| 3-201-2-WTH | WTH | Y | Access Trunk Hatch | 120.45 | -1.00 | 5.77 |
| 3-172-1-WTD | WTD | Y | Compartment Access | 103.17 | 3.44 | 5.30 |
| 3-172-4-D | NTD | X | Non-tight Door | 103.15 | -2.43 | 5.30 |
| 3-171-2-D | NTD | X | Non-tight Door | 102.70 | -1.37 | 5.29 |
| 3-171-4-T2 | T2 | X | Trunk | 102.53 | -5.39 | 5.28 |
| 3-169-1-WTH | WTH | Y | Access Trunk Hatch | 101.26 | 4.06 | 5.25 |
| 3-159-2-WTD | WTD | X | Escape Trunk Access | 95.40 | -5.20 | 5.09 |
| 3-157-2-D | NTD | X | Non-tight Door | 93.60 | -4.37 | 5.04 |
| 3-156-1-D | NTD | X | Non-tight Door | 93.43 | 3.78 | 5.03 |
| 3-156-8-D | NTD | X | Non-tight Door | 93.00 | -4.90 | 5.02 |
| 3-154-2-D | NTD | X | Non-tight Door | 92.40 | -2.07 | 5.01 |
| 3-153-1-D | NTD | X | Non-tight Door | 91.80 | 6.29 | 4.99 |
| 3-151-1-WTH | WTH | Y | Access Trunk Hatch | 90.74 | 4.31 | 4.96 |

| Node | Type | Fitting Mark | Description | X (m) | Y (m) | Z (m) |
|-------------|-------------|---------------------|---------------------|------------------|------------------|------------------|
| 3-150-1-WTD | WTD | Y | Compartment Access | 89.49 | 5.94 | 4.93 |
| 3-149-1-D | NTD | X | Non-tight Door | 89.20 | 2.19 | 4.92 |
| 3-149-3-WTD | WTD | Y | Compartment Access | 88.76 | 3.64 | 4.91 |
| 3-143-4-WTD | WTD | Y | Compartment Access | 85.76 | -5.62 | 4.83 |
| 3-141-2-WTH | WTH | Y | Access Trunk Hatch | 84.45 | -4.68 | 4.79 |
| 3-139-2-WTD | WTD | Y | Compartment Access | 83.40 | -3.74 | 4.76 |
| 3-135-1-WTD | WTD | X | Escape Trunk Access | 81.05 | 6.24 | 4.70 |
| 3-133-2-WTD | WTD | X | Escape Trunk Access | 79.80 | -6.24 | 4.67 |
| 3-116-1-WTD | WTD | Y | Compartment Access | 69.63 | 7.26 | 4.39 |
| 3-111-1-WTD | WTD | Y | Compartment Access | 66.68 | 1.04 | 4.31 |
| 3-110-1-WTD | WTD | Y | Compartment Access | 66.18 | 0.35 | 4.31 |
| 3-99-1-WTD | WTD | X | Escape Trunk Access | 59.40 | 6.24 | 4.31 |
| 3-85-2-WTD | WTD | Y | Compartment Access | 50.96 | -7.27 | 4.31 |
| 3-76-2-WTD | WTD | X | Escape Trunk Access | 45.60 | -6.84 | 4.31 |
| 3-70-3-WTD | WTD | Y | Compartment Access | 42.10 | 6.14 | 4.31 |
| 3-68-1-WTH | WTH | Y | Access Trunk Hatch | 40.60 | 5.20 | 4.31 |
| 3-66-2-WTH | WTH | Y | Access Trunk Hatch | 39.67 | -4.16 | 4.31 |
| 3-64-1-WTD | WTD | Y | Compartment Access | 38.62 | 3.08 | 4.31 |
| 3-64-2-WTD | WTD | Y | Compartment Access | 38.45 | -4.68 | 4.31 |
| 3-62-2-T2 | T2 | X | Trunk | 37.26 | -6.83 | 4.31 |
| 3-61-1-WTD | WTD | Y | Compartment Access | 36.70 | 3.12 | 4.31 |
| 3-59-3-WTH | WTH | Y | Access Trunk Hatch | 35.25 | 2.65 | 4.31 |
| 3-57-2-D | NTD | X | Non-tight Door | 34.20 | -3.70 | 4.31 |
| 3-56-1-WTD | WTD | Y | Compartment Access | 33.30 | 3.70 | 4.31 |
| 3-54-5-D | NTD | X | Non-tight Door | 32.60 | 4.16 | 4.31 |
| 3-54-3-D | NTD | X | Non-tight Door | 32.45 | 3.12 | 4.31 |
| 3-54-1-D | NTD | X | Non-tight Door | 32.45 | 0.68 | 4.31 |
| 3-54-2-D | NTD | X | Non-tight Door | 32.45 | -1.70 | 4.31 |
| 3-53-6-D | NTD | X | Non-tight Door | 31.70 | -4.10 | 4.31 |

| Node | Type | Fitting Mark | Description | X (m) | Y (m) | Z (m) |
|-------------|-------------|---------------------|--------------------|------------------|------------------|------------------|
| 3-51-2-D | NTD | X | Non-tight Door | 30.60 | -3.70 | 4.31 |
| 3-49-1-D | NTD | X | Non-tight Door | 29.45 | 3.12 | 4.31 |
| 3-37-3-D | NTD | X | Non-tight Door | 22.01 | 3.82 | 4.31 |
| 3-37-1-D | NTD | X | Non-tight Door | 22.00 | 1.45 | 4.31 |
| 3-37-2-D | NTD | X | Non-tight Door | 22.00 | -1.70 | 4.31 |
| 3-37-4-D | NTD | X | Non-tight Door | 22.00 | -4.68 | 4.31 |
| 3-36-5-D | NTD | X | Non-tight Door | 21.50 | 4.33 | 4.31 |
| 3-36-8-D | NTD | X | Non-tight Door | 21.49 | -5.90 | 4.31 |
| 3-35-2-D | NTD | X | Non-tight Door | 21.00 | -4.92 | 4.31 |
| 3-32-3-T2 | T2 | X | Trunk | 19.35 | 7.16 | 4.31 |
| 3-22-2-T1 | T1 | Y | Access Trunk | 13.39 | -3.62 | 4.31 |
| 2-214-2-WTD | WTD | Y | Fore Peak Access | 128.00 | -1.50 | 7.754 |
| 2-209-2-WTS | WTS | X | Scuttle | 125.38 | -1.54 | 7.683 |
| 2-208-2-WTD | WTD | X | Subdivision | 124.80 | -2.92 | 7.668 |
| 2-203-2-D | NTD | X | Non-tight Door | 121.82 | -2.81 | 7.587 |
| 2-200-2-WTH | WTH | Y | Hatch | 120.24 | -2.04 | 7.544 |
| 2-199-1-WTD | WTD | Z | Compartment Access | 119.35 | 3.73 | 7.520 |
| 2-198-4-WTD | WTD | Z | Compartment Access | 118.98 | -3.29 | 7.510 |
| 2-190-2-WTD | WTD | X | Subdivision | 114.00 | -4.75 | 7.376 |
| 2-190-1-WTD | WTD | X | Subdivision | 114.50 | 4.75 | 7.389 |
| 2-189-1-WTD | WTD | Z | Compartment Access | 113.43 | 2.88 | 7.361 |
| 2-188-2-WTD | WTD | Z | Compartment Access | 112.80 | -0.51 | 7.343 |
| 2-187-2-D | NTD | X | Non-tight Door | 112.20 | -4.42 | 7.327 |
| 2-173-1-WTD | WTD | X | Subdivision | 103.80 | 6.17 | 7.100 |
| 2-173-2-WTD | WTD | X | Subdivision | 103.80 | -6.17 | 7.100 |
| 2-172-4-D | NTD | X | Non-tight Door | 103.30 | -4.92 | 7.087 |
| 2-172-5-D | NTD | X | Non-tight Door | 103.28 | 5.65 | 7.086 |
| 2-171-3-D | NTD | X | Non-tight Door | 102.90 | 2.76 | 7.076 |
| 2-171-1-D | NTD | X | Non-tight Door | 102.90 | 0.21 | 7.076 |

| Node | Type | Fitting Mark | Description | X (m) | Y (m) | Z (m) |
|-------------|-------------|---------------------|---------------------|------------------|------------------|------------------|
| 2-171-2-D | NTD | X | Non-tight Door | 102.90 | -3.63 | 7.076 |
| 2-169-1-WTH | WTH | Y | Hatch | 101.22 | 5.21 | 7.030 |
| 2-165-3-WTD | WTD | Z | Compartment Access | 99.40 | 5.92 | 6.981 |
| 2-164-1-WTD | WTD | X | Subdivision | 98.40 | 6.76 | 6.954 |
| 2-164-2-WTD | WTD | X | Subdivision | 98.40 | -6.76 | 6.954 |
| 2-162-1-WTD | WTD | X | Subdivision | 97.19 | 6.76 | 6.921 |
| 2-162-2-WTD | WTD | X | Subdivision | 97.19 | -6.76 | 6.921 |
| 2-160-6-WTD | WTD | X | Escape Trunk Access | 96.00 | -5.70 | 6.889 |
| 2-156-3-D | NTD | X | Non-tight Door | 93.70 | 4.93 | 6.827 |
| 2-156-1-D | NTD | X | Non-tight Door | 93.70 | 1.44 | 6.827 |
| 2-156-2-D | NTD | X | Non-tight Door | 93.70 | -0.67 | 6.827 |
| 2-156-4-D | NTD | X | Non-tight Door | 93.70 | -4.13 | 6.827 |
| 2-154-3-D | NTD | X | Non-tight Door | 92.72 | 3.61 | 6.801 |
| 2-154-1-D | NTD | X | Non-tight Door | 92.72 | 0.12 | 6.801 |
| 2-154-2-D | NTD | X | Non-tight Door | 92.72 | -1.99 | 6.801 |
| 2-154-4-D | NTD | X | Non-tight Door | 92.72 | -5.44 | 6.801 |
| 2-153-3-WTD | WTD | Y | Access Trunk | 92.13 | 6.66 | 6.785 |
| 2-152-1-WTH | WTH | Y | Hatch | 90.91 | 5.33 | 6.752 |
| 2-147-2-WTD | WTD | X | Subdivision | 88.20 | -7.55 | 6.679 |
| 2-147-1-WTD | WTD | X | Subdivision | 88.20 | 7.56 | 6.679 |
| 2-143-2-D | NTD | X | Non-tight Door | 85.57 | -7.04 | 6.608 |
| 2-141-1-D | NTD | X | Non-tight Door | 84.80 | 7.12 | 6.587 |
| 2-140-2-WTH | WTH | Y | Hatch | 84.15 | -6.26 | 6.569 |
| 2-139-2-WTD | WTD | Y | Access Trunk | 83.10 | -7.16 | 6.541 |
| 2-134-1-WTD | WTD | X | Subdivision | 80.40 | 7.90 | 6.468 |
| 2-136-1-WTD | WTD | X | Escape Trunk Access | 81.60 | 6.76 | 6.500 |
| 2-134-4-WTD | WTD | X | Subdivision | 80.38 | -7.90 | 6.467 |
| 2-132-2-WTD | WTD | X | Escape Trunk Access | 79.20 | -6.76 | 6.435 |
| 2-131-3-D | NTD | X | Non-tight Door | 78.60 | 7.28 | 6.419 |

| Node | Type | Fitting Mark | Description | X (m) | Y (m) | Z (m) |
|-------------|-------------|---------------------|---------------------|------------------|------------------|------------------|
| 2-130-4-D | NTD | X | Non-tight Door | 78.00 | -6.24 | 6.403 |
| 2-121-2-D | NTD | X | Non-tight Door | 72.40 | -7.28 | 6.252 |
| 2-121-1-WTD | WTD | Y | Access Trunk | 72.33 | 7.28 | 6.250 |
| 2-119-1-WTH | WTH | Y | Hatch | 71.18 | 6.71 | 6.219 |
| 2-112-1-WTD | WTD | X | Subdivision | 67.20 | 7.99 | 6.111 |
| 2-112-2-WTD | WTD | X | Subdivision | 67.20 | -7.99 | 6.111 |
| 2-110-1-WTD | WTD | X | Subdivision | 66.00 | 7.99 | 6.095 |
| 2-110-2-WTD | WTD | X | Subdivision | 66.00 | -7.99 | 6.095 |
| 2-110-0-D | NTD | X | Non-tight Door | 65.90 | 0.52 | 6.095 |
| 2-105-1-WTD | WTD | Y | Access Trunk | 62.91 | 1.22 | 6.095 |
| 2-104-2-D | NTD | X | Non-tight Door | 62.70 | -7.28 | 6.095 |
| 2-104-1-D | NTD | X | Non-tight Door | 62.42 | 0.52 | 6.095 |
| 2-101-1-WTD | WTD | X | Subdivision | 60.00 | 8.05 | 6.095 |
| 2-101-2-WTD | WTD | X | Subdivision | 60.00 | -8.05 | 6.095 |
| 2-97-1-WTD | WTD | X | Escape Trunk Access | 58.80 | 6.76 | 6.095 |
| 2-96-2-D | NTD | X | Non-tight Door | 57.70 | -7.28 | 6.095 |
| 2-96-3-D | NTD | X | Non-tight Door | 57.47 | 6.24 | 6.095 |
| 2-91-1-D | NTD | X | Non-tight Door | 54.60 | 7.28 | 6.095 |
| 2-83-4-WTH | WTH | Y | Hatch | 49.59 | -6.70 | 6.095 |
| 2-80-2-WTD | WTD | Y | Access Trunk | 48.00 | -6.71 | 6.095 |
| 2-78-1-WTD | WTD | X | Subdivision | 46.80 | 7.97 | 6.095 |
| 2-77-4-WTD | WTD | X | Escape Trunk Access | 46.21 | -7.28 | 6.095 |
| 2-78-6-WTD | WTD | X | Subdivision | 46.80 | -7.97 | 6.095 |
| 2-72-1-D | NTD | X | Non-tight Door | 43.00 | 7.28 | 6.095 |
| 2-71-2-D | NTD | X | Non-tight Door | 42.70 | -7.28 | 6.095 |
| 2-66-1-WTD | WTD | Y | Access Trunk | 39.39 | 7.28 | 6.095 |
| 2-63-1-WTD | WTD | X | Subdivision | 38.30 | 7.87 | 6.095 |
| 2-63-2-WTD | WTD | X | Subdivision | 38.30 | -7.87 | 6.095 |
| 2-62-5-WTD | WTD | X | Subdivision | 37.80 | 7.88 | 6.095 |

| Node | Type | Fitting Mark | Description | X (m) | Y (m) | Z (m) |
|-------------|-------------|---------------------|--------------------|------------------|------------------|------------------|
| 2-62-4-WTD | WTD | X | Subdivision | 37.27 | -7.88 | 6.095 |
| 2-62-2-S | WTS | X | Scuttle | 37.27 | -6.83 | 6.095 |
| 2-62-3-WTD | WTD | Y | Access Trunk | 37.20 | 4.94 | 6.095 |
| 2-62-1-WTD | WTD | Y | Access Trunk | 37.20 | 3.12 | 6.095 |
| 2-58-3-WTH | WTH | Y | Hatch | 35.08 | 3.67 | 6.095 |
| 2-58-3-D | NTD | X | Non-tight Door | 34.62 | 7.28 | 6.095 |
| 2-51-2-WTD | WTD | Z | Compartment Access | 30.61 | -2.08 | 6.095 |
| 2-51-4-D | NTD | X | Non-tight Door | 30.60 | -5.55 | 6.095 |
| 2-49-1-D | NTD | X | Non-tight Door | 29.69 | 5.24 | 6.095 |
| 2-49-2-WTD | WTD | Z | Compartment Access | 29.69 | -1.03 | 6.095 |
| 2-49-4-D | NTD | X | Non-tight Door | 29.69 | -5.24 | 6.095 |
| 2-44-1-WTD | WTD | X | Subdivision | 26.40 | 7.80 | 6.095 |
| 2-44-2-WTD | WTD | X | Subdivision | 26.40 | -7.80 | 6.095 |
| 2-40-6-WTH | WTH | Y | Hatch | 23.87 | -6.73 | 6.095 |
| 2-37-3-D | NTD | X | Non-tight Door | 21.93 | 4.76 | 6.095 |
| 2-37-1-D | NTD | X | Non-tight Door | 21.93 | 1.94 | 6.095 |
| 2-37-2-D | NTD | X | Non-tight Door | 21.93 | -1.62 | 6.095 |
| 2-37-4-D | NTD | X | Non-tight Door | 21.93 | -4.44 | 6.095 |
| 2-36-8-D | NTD | X | Non-tight Door | 21.38 | -5.31 | 6.095 |
| 2-36-5-D | NTD | X | Non-tight Door | 21.36 | 5.72 | 6.095 |
| 2-35-2-D | NTD | X | Non-tight Door | 20.92 | -0.37 | 6.095 |
| 2-35-4-D | NTD | X | Non-tight Door | 20.92 | -3.94 | 6.095 |
| 2-33-1-D | NTD | X | Non-tight Door | 19.65 | 5.72 | 6.095 |
| 2-32-1-S | WTS | X | Scuttle | 19.35 | 7.14 | 6.095 |
| 2-27-2-WTD | WTD | X | Subdivision | 16.20 | -7.52 | 6.095 |
| 2-27-1-WTD | WTD | X | Subdivision | 16.20 | 6.29 | 6.095 |
| 2-25-2-D | NTD | X | Non-tight Door | 15.00 | -6.50 | 6.095 |
| 2-24-2-WTD | WTD | Z | Compartment Access | 14.50 | -4.17 | 6.095 |
| 2-22-2-WTH | WTH | Y | Hatch | 13.38 | -3.64 | 6.095 |

| Node | Type | Fitting Mark | Description | X (m) | Y (m) | Z (m) |
|-------------|-------------|---------------------|--------------------|------------------|------------------|------------------|
| 2-9-2-WTD | WTD | X | Subdivision | 5.38 | -2.58 | 6.095 |
| 2-8-2-WTD | WTD | Z | Compartment Access | 4.85 | -2.56 | 6.095 |
| 2-8-3-S | WTS | X | Scuttle | 4.85 | 6.60 | 6.095 |
| 2-5-3-WTD | WTD | Z | Compartment Access | 2.80 | 4.16 | 6.095 |
| 2-3-1-WTD | WTD | Z | Compartment Access | 1.80 | 3.15 | 6.095 |
| 2-2-2-WTS | WTS | X | Scuttle | 1.34 | -2.70 | 6.095 |
| 2-1-2-WTD | WTD | Z | Compartment Access | 0.75 | -3.61 | 6.095 |
| 1-214-2-WTS | WTS | X | Scuttle | 128.9 | -2.293 | 11.49 |
| 1-196-2-WTS | WTS | X | Scuttle | 118.02 | -2.295 | 11.20 |
| 1-189-2-WTS | WTS | X | Scuttle | 113.5 | -1.552 | 11.08 |
| 1-187-1-WTS | WTS | X | Scuttle | 112.25 | 0.5 | 11.04 |
| 1-165-1-WTS | WTS | X | Scuttle | 99.17 | 5.13 | 10.69 |
| 1-164-1-WTD | WTD | X | Forecastle WTD | 98.40 | 7.56 | 10.67 |
| 1-158-1-ATD | ATD | Y | Compartment Access | 94.80 | 7.67 | 10.57 |
| 1-158-2-D | NTD | X | Non-tight Door | 94.80 | -0.49 | 10.57 |
| 1-158-4-ATD | ATD | Y | Compartment Access | 94.80 | -5.70 | 10.57 |
| 1-151-1-WTH | WTH | Y | Hatch | 90.75 | 6.24 | 10.46 |
| 1-150-1-ATD | ATD | Y | Compartment Access | 89.70 | 7.07 | 10.43 |
| 1-143-2-ATD | ATD | Y | Compartment Access | 86.04 | -7.69 | 10.34 |
| 1-143-1-ATD | ATD | Y | Compartment Access | 85.85 | 7.18 | 10.33 |
| 1-139-2-D | NTD | X | Non-tight Door | 83.40 | -2.50 | 10.26 |
| 1-138-2-ATD | ATD | Y | Compartment Access | 82.79 | -7.75 | 10.25 |
| 1-131-1-D | NTD | X | Non-tight Door | 78.60 | 7.28 | 10.13 |
| 1-128-2-D | NTD | X | Non-tight Door | 76.80 | -7.78 | 10.09 |
| 1-121-2-D | NTD | X | Non-tight Door | 72.90 | -7.78 | 9.98 |
| 1-121-1-ATD | ATD | Y | Compartment Access | 72.30 | 7.28 | 9.96 |
| 1-119-1-WTH | WTH | Y | Hatch | 71.11 | 6.71 | 9.93 |
| 1-117-1-D | NTD | X | Non-tight Door | 70.20 | 4.85 | 9.91 |
| 1-114-2-D | NTD | X | Non-tight Door | 68.40 | -2.64 | 9.86 |

| Node | Type | Fitting Mark | Description | X (m) | Y (m) | Z (m) |
|-------------|-------------|---------------------|--------------------|------------------|------------------|------------------|
| 1-114-4-D | NTD | X | Non-tight Door | 68.40 | -6.09 | 9.86 |
| 1-112-1-ATD | ATD | Y | Compartment Access | 67.20 | 6.93 | 9.83 |
| 1-112-2-ATD | ATD | Y | Compartment Access | 67.20 | -8.30 | 9.83 |
| 1-109-1-ATD | ATD | Y | Compartment Access | 65.40 | 6.94 | 9.81 |
| 1-110-2-ATD | ATD | Y | Compartment Access | 66.00 | -8.30 | 9.81 |
| 1-107-1-D | NTD | X | Non-tight Door | 63.99 | 6.10 | 9.81 |
| 1-106-1-D | NTD | X | Non-tight Door | 63.60 | 2.05 | 9.81 |
| 1-106-2-D | NTD | X | Non-tight Door | 63.60 | -2.04 | 9.81 |
| 1-103-1-D | NTD | X | Non-tight Door | 61.80 | 2.02 | 9.81 |
| 1-102-2-D | NTD | X | Non-tight Door | 61.11 | -7.81 | 9.81 |
| 1-97-2-D | NTD | X | Non-tight Door | 58.53 | -7.81 | 9.81 |
| 1-93-3-D | NTD | X | Non-tight Door | 56.00 | 3.40 | 9.81 |
| 1-92-2-D | NTD | X | Non-tight Door | 55.34 | -7.81 | 9.81 |
| 1-87-2-D | NTD | X | Non-tight Door | 52.49 | -7.80 | 9.81 |
| 1-86-3-D | NTD | X | Non-tight Door | 51.31 | 3.40 | 9.81 |
| 1-83-2-WTH | WTH | Y | Hatch | 49.66 | -5.72 | 9.81 |
| 1-83-3-D | NTD | X | Non-tight Door | 49.66 | 3.60 | 9.81 |
| 1-80-2-ATD | ATD | Y | Compartment Access | 48.00 | -4.70 | 9.81 |
| 1-71-3-ATD | ATD | Y | Compartment Access | 42.60 | 3.40 | 9.81 |
| 1-70-2-ATD | ATD | Y | Compartment Access | 42.00 | -1.29 | 9.81 |
| 1-71-4-ATD | ATD | Y | Compartment Access | 42.55 | -3.12 | 9.81 |
| 1-65-1-ATD | ATD | Y | Compartment Access | 39.00 | 2.34 | 9.81 |
| 1-63-1-ATD | ATD | Y | Compartment Access | 37.80 | 2.34 | 9.81 |
| 1-61-3-D | NTD | X | Non-tight Door | 36.67 | 4.16 | 9.81 |
| 1-58-3-WTH | WTH | Y | Hatch | 34.90 | 3.68 | 9.81 |
| 1-53-2-T2 | T2 | X | Scuttle | 32.00 | -4.57 | 9.81 |
| 1-52-2-ATD | ATD | Y | Compartment Access | 31.20 | -4.16 | 9.81 |
| 1-49-1-S | S | X | Scuttle | 28.97 | 2.16 | 9.81 |
| 1-48-1-ATD | ATD | Y | Compartment Access | 28.55 | 2.38 | 9.81 |

| Node | Type | Fitting Mark | Description | X (m) | Y (m) | Z (m) |
|--------------|-------------|---------------------|--------------------|------------------|------------------|------------------|
| 1-46-1-ATD | ATD | Y | Compartment Access | 27.62 | 1.56 | 9.81 |
| 1-44-1-WTD | WTD | X | Flight Deck WTD | 26.40 | 2.38 | 9.81 |
| 1-44-2-ATD | ATD | Y | Compartment Access | 26.40 | 1.30 | 9.81 |
| 1-8-1-WTS | WTS | X | Scuttle | 4.85 | 6.63 | 9.81 |
| 1-(1)-2-WTH | WTH | Y | Hatch | -0.88 | -3.65 | 9.81 |
| 01-147-2-ATD | ATD | Y | Airtight Door | 88.21 | -4.75 | 13.19 |
| 01-147-1-ATD | ATD | Y | Airtight Door | 88.21 | 4.68 | 13.19 |
| 01-145-1-ATH | ATH | Y | Hatch | 87.14 | 6.30 | 13.16 |
| 01-142-1-D | NTD | Z | Compartment Access | 85.20 | 4.11 | 13.11 |
| 01-133-2-S | WTS | X | Scuttle | 79.94 | -6.79 | 12.97 |
| 01-125-2-ATD | ATD | Y | Airtight Door | 75.00 | -7.28 | 12.83 |
| 01-116-2-ATH | ATH | Y | Hatch | 69.46 | -6.97 | 12.68 |
| 01-114-2-ATD | ATD | Y | Airtight Door | 68.40 | -7.86 | 12.65 |
| 01-112-2-ATD | ATD | Y | Airtight Door | 67.20 | -7.86 | 12.62 |
| 01-99-3-WTS | WTS | X | Scuttle | 59.46 | 6.73 | 12.61 |
| 01-91-1-ATD | ATD | Y | Airtight Door | 54.60 | 4.16 | 12.61 |
| 01-88-1-ATD | ATD | Y | Airtight Door | 53.00 | 3.33 | 12.61 |
| 01-87-1-ATD | ATD | Y | Airtight Door | 52.35 | 2.86 | 12.61 |
| 01-86-1-ATD | ATD | Y | Airtight Door | 51.60 | 2.07 | 12.61 |
| 01-85-2-ATD | ATD | Y | Airtight Door | 51.21 | -4.51 | 12.61 |
| 01-84-1-ATD | ATD | Y | Airtight Door | 50.40 | 2.03 | 12.61 |
| 01-82-2-ATH | ATH | Y | Hatch | 49.32 | -3.56 | 12.61 |
| 01-82-4-ATD | ATD | Y | Airtight Door | 49.20 | -4.68 | 12.61 |
| 01-80-2-D | NTD | Z | Compartment Access | 47.60 | -3.56 | 12.61 |
| 01-74-2-S | WTS | X | Scuttle | 44.25 | -2.08 | 12.61 |
| 01-71-3-D | NTD | Z | Compartment Access | 42.89 | 2.60 | 12.61 |
| 01-66-1-ATD | ATD | Y | Airtight Door | 39.60 | 2.12 | 12.61 |
| 01-65-2-ATD | ATD | Y | Airtight Door | 39.00 | -4.68 | 12.61 |
| 01-63-2-ATD | ATD | Y | Airtight Door | 37.80 | -4.68 | 12.61 |

| Node | Type | Fitting Mark | Description | X (m) | Y (m) | Z (m) |
|--------------|-------------|---------------------|--------------------|------------------|------------------|------------------|
| 01-63-1-ATD | ATD | Y | Airtight Door | 37.80 | 2.12 | 12.61 |
| 01-62-1-S | WTS | X | Scuttle | 37.42 | 1.96 | 12.61 |
| 01-58-3-ATH | ATH | Y | Hatch | 35.09 | 3.65 | 12.61 |
| 01-57-4-ATD | ATD | Y | Airtight Door | 34.20 | -5.21 | 12.61 |
| 01-53-2-S | WTS | X | Scuttle | 32.01 | -4.59 | 12.61 |
| 01-51-2-ATD | ATD | Y | Airtight Door | 30.60 | -4.67 | 12.61 |
| 01-48-1-ATD | ATD | Y | Airtight Door | 29.00 | 2.08 | 12.61 |
| 01-48-3-S | WTS | X | Scuttle | 28.60 | 2.72 | 12.61 |
| 02-157-3-ATD | ATD | Y | Airtight Door | 94.20 | 6.76 | 16.16 |
| 02-157-1-ATD | ATD | Y | Airtight Door | 94.20 | 6.18 | 16.16 |
| 02-157-2-ATD | ATD | Y | Airtight Door | 94.20 | -6.18 | 16.16 |
| 02-157-4-ATD | ATD | Y | Airtight Door | 94.20 | -6.76 | 16.16 |
| 02-153-1-ATD | ATD | Y | Airtight Door | 91.51 | 4.22 | 16.08 |
| 02-153-2-ATD | ATD | Y | Airtight Door | 91.51 | -4.22 | 16.08 |
| 02-149-4-D | NTD | Z | Non-tight Door | 89.36 | -1.15 | 16.03 |
| 02-146-2-D | NTD | Z | Non-tight Door | 87.69 | -1.15 | 15.98 |
| 02-146-1-D | NTD | Z | Non-tight Door | 87.69 | 1.20 | 15.98 |
| 02-146-4-ATH | ATH | Y | Hatch | 87.48 | -3.61 | 15.97 |
| 02-146-3-ATH | ATH | Y | Hatch | 87.47 | 3.72 | 15.97 |
| 02-135-1-WTS | WTS | X | Scuttle | 80.94 | 6.76 | 15.80 |
| 02-77-2-WTS | WTS | X | Scuttle | 46.23 | -6.73 | 15.41 |
| 02-74-2-WTS | WTS | X | Scuttle | 44.25 | -2.11 | 15.41 |
| 02-62-1-WTS | WTS | X | Scuttle | 37.36 | 1.93 | 15.41 |
| 02-58-1-WTH | WTH | X | Hatch | 34.96 | 3.67 | 15.41 |
| 02-48-1-WTS | WTS | X | Scuttle | 28.60 | 2.70 | 15.41 |
| 03-148-1-T2 | T2 | Null | Vertical Trunk | 88.5 | 5.35 | 19.065 |
| 03-148-2-T2 | T2 | Null | Vertical Trunk | 88.5 | -5.35 | 19.065 |

Table 25. Closure location on ÁLVARO DE BAZÁN frigate.

INITIAL DISTRIBUTION LIST

1. Defense Technical Information Center
Ft. Belvoir, Virginia
2. Dudley Knox Library
Naval Postgraduate School
Monterey, California
3. Javier Salmeron, Code OR/Sa
Naval Postgraduate School
Monterey, California
4. Kevin Wood, Code OR/Wd
Naval Postgraduate School
Monterey, California